

Standard Finish: M32-ST-TR-SAT

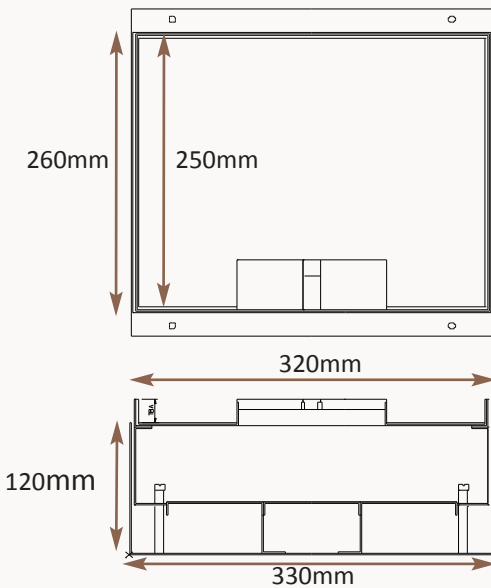

Frame size 320x250mm
Base box size 330x260mm
Lid recess - advise on order to suit floor covering
Base with 20 & 25mm conduit knockouts in base and sides

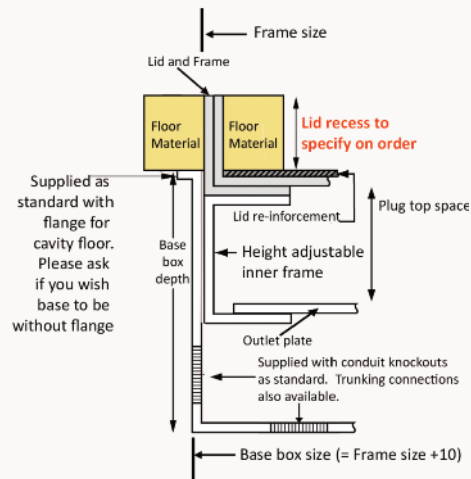
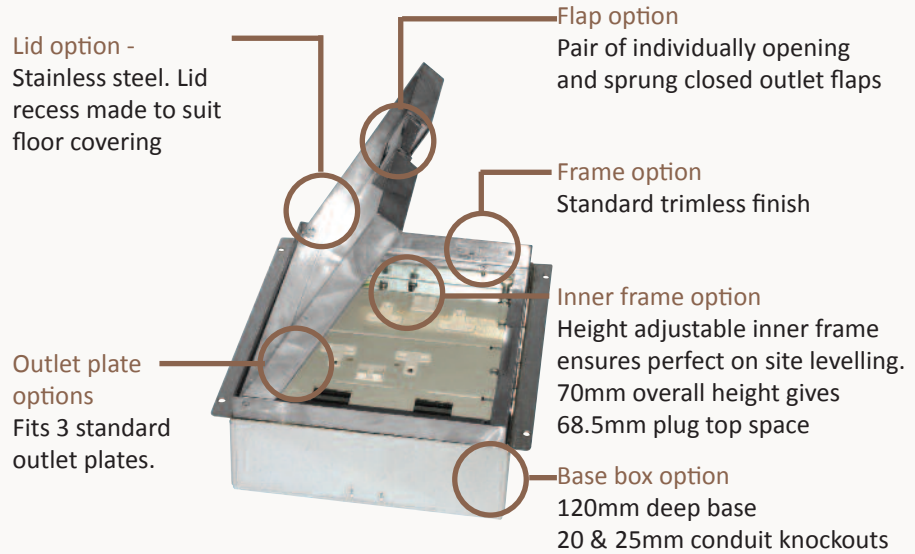

Other Options for the M32-ST:

M32-ST-FL-SAT	Satin stainless steel trim flange, recessed lid
M32-ST-FL-MIR	Mirror Polished stainless steel trim flange, recessed lid
M32-ST-TR-MIR	Mirror Polished stainless steel trimless, recessed lid
MIN-FLTLID	Extra to a flat instead of recessed lid
MIN-LOCK	Extra to supply lid and frame with a cam lock
MIN-IP65	Extra to supply the frame as sealed to IP65 when not in use
SB73RETRO	Retro stlye base box fitting entirely within frame

IMAGE TO FOLLOW



IMAGE TO FOLLOW



IMAGE TO FOLLOW

