



FLOOR BOX OVERVIEW



DISCREET Lids



TAILORED Shapes

CONTENTS



- 1 **About Us**
- 2 **Floor box type and attributes**
- 3 **Floor box Chooser - make specifying your floor box easier**
- 5 **Two premier floor box ranges**
- 6 **Minima -**
 - 8 - Rectangle/Square Standard assembly
 - 10 - Rectangle/Square Retrofit
 - 12 - Round Standard assembly
 - 13 - Round Retrofit
- 14 **700 Series -**
 - 16 - Rectangle/Square Standard assembly
 - 18 - Rectangle/Square Retrofit
 - 20 - Round Standard assembly
 - 21 - Round Retrofit
- 22 **Access Grommets -**
 - 24 - Standard Assembly
 - 25 - Retrofit
- 26 **500 Series**
- 29 **2000 Series**
- 32 **Tailored Solutions**
- 33 **Outlet Plates**
 - 34 - Double Outlet Plates
 - 37 - Single Outlet Plates
- 39 **Trunking**

ABOUT US

THE UK'S LEADING CABLE MANAGEMENT EXPERTS

Cableduct manufactures premium quality floor boxes and cable management solutions. These range from standard products to tailored solutions designed in collaboration with client teams.

Our floor boxes are hand-finished with great care here in the UK and can be any size, shape and finish so they match our customer's design perfectly.

We are a family-owned business that has been manufacturing in the UK for 50 years, something of which we are very proud.

The secret of our longevity and success is undoubtedly our team and we all take great pride in providing the highest quality products and service to our customers.

We have global reach and operate in all sectors in the UK and internationally. Our most prominent sectors include: hospitality, commercial, prime residential, retail, palaces and heritage.

Our customers are at the heart of everything we do and it is their challenges and feedback that drive us. We enjoy working with all customer segments, including but not limited to: architects, designers, consultants, contractors, wholesalers and homeowners.

We believe what sets us apart is our collaborative approach to working with customers and our focus on providing outstanding quality products and service, tailored to our customers' specific needs.

FLOOR BOX RANGES

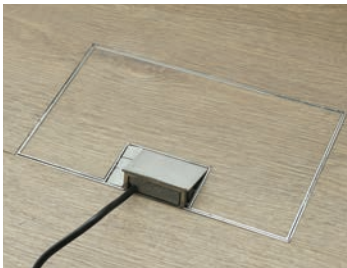

Minima



700 Series



Access Grommets



500 Series



2000 Series

Floor box type and attributes

KEY PRODUCT ATTRIBUTES		2000	500	ACCESS GROMMET	700	MINIMA
SHAPE	Rectangular	Y	Y		Y	Y
	Square				Y	Y
	Round			Y	Y	Y
	Bespoke				Y	Y
FINISH	Stainless steel			Y	Y	Y
	Satin brass and bronze / brass lacquer finish			Y	Y	Y
	Powdercoat			Y	Y	Y
	Mirror polished flap, handle and lid-frame				Y	Y
	Unbranded (no Cableduct branding)		Y	Y		Y
	Style	Plastic trim	Shallow	Access only	Classic	Contemporary
	Plastic PC / ABS trim flange (fire retardant)	Y				
SIZE	No. Compartments / outlet plates	3 to 4	1 to 4	N/A	1 to 4	1 to 4
	Base box depth (mm)	55-120	55-120	65	65-120	65-120
	Min height required for floor box (base box bottom to top of floor covering)	62	62	68	75	75
FLOOR COVERING DEPTH	Lid recess - up to 6mm (fixed)	Y	Y			
	Lid recess - up to 30mm			Y	Y	Y
INSTALLATION	Retrofit installation (retro)			Y	Y	Y
	Trim flange (option for 700/Minima/Access Grommet)	Y	N	Y	Y	Y
OPTIONS	Flat lid (completely metal; no recess)		Y	Y	Y	Y
	Extra strength lid				Y	Y
	Brush cable exit					Y
	Mousehole cable exit				Y	Y
	IP65 - when not in use				Y	Y
	Access hole closer			Y		

FLOOR BOX CHOOSER

MAKE SPECIFYING YOUR FLOOR BOX EASIER

1. Pick Your Size

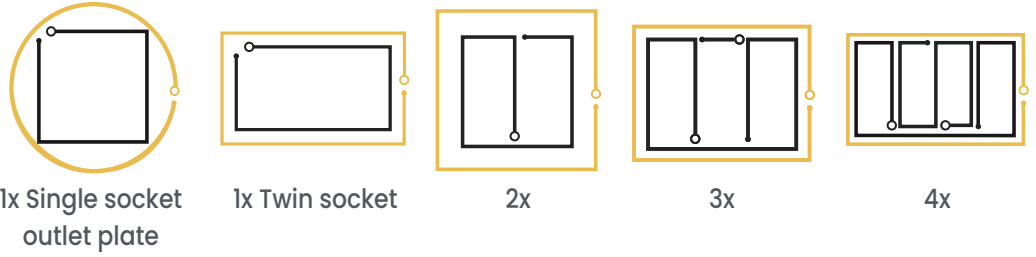

2. Select a Shape

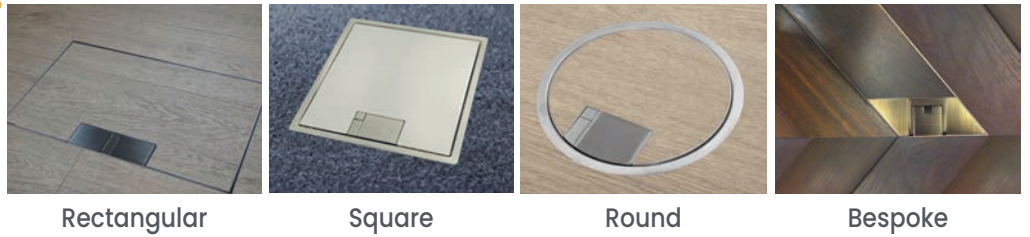

3. Select Product



4. Select a Finish

Standard Finishes



Special Finishes

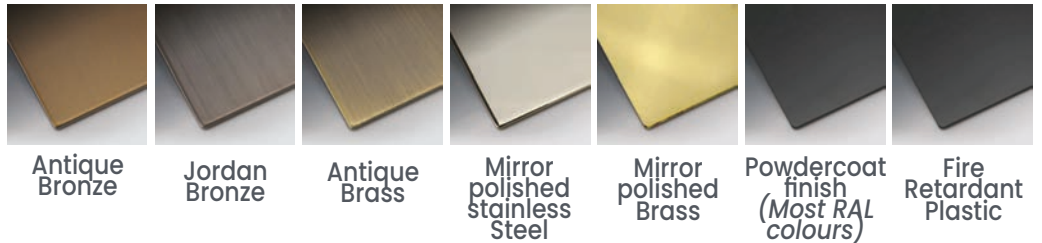

5. Select a Base Depth

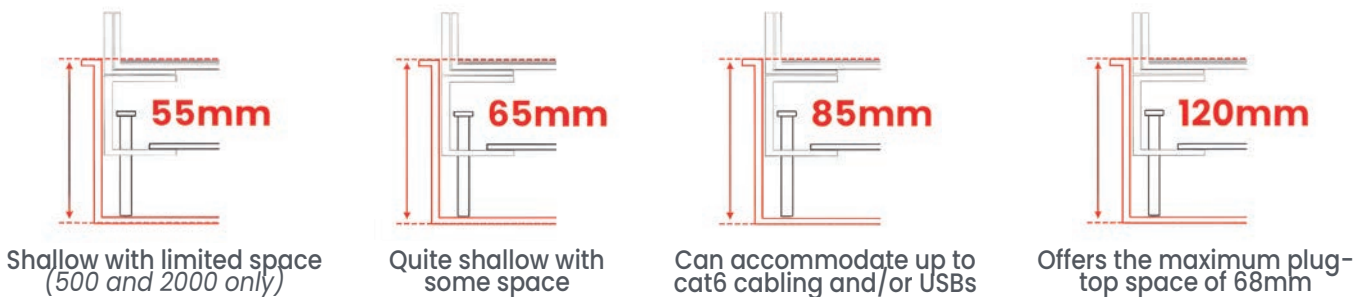

6. Select a Timing

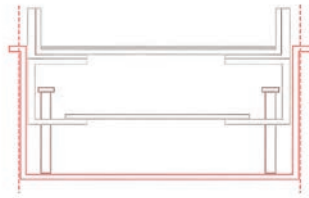

Standard floor box with fixing flange
(base box installed BEFORE final floor is fitted)

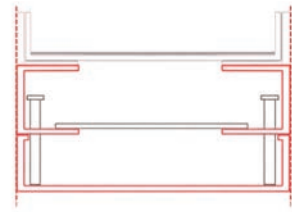

Retrofit floor box without fixing flange
(floor box installed AFTER final floor is fitted or with a poured finish, i.e. terrazzo/polished screed)

7. Select a Feed Type

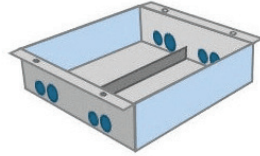

Cable/Conduit

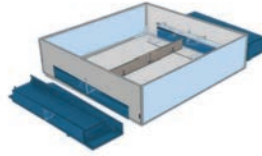

Trunking - In Screed

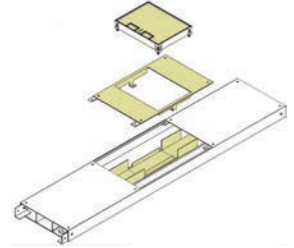

Trunking - Flush Floor
(500 & 2000 only)

8. Lid Recess Depth



Shallow carpet/
Vinyl (1mm-6mm
deep)



Carpet
(3mm-25mm
deep)



Timber/Engineered
wood (7mm-
25mm deep)



Porcelain/Stone
tiles (9mm-
25mm)



Poured finish
(screed, concrete,
terrazzo, resin)



Flat lid (metal top;
no lid recess)

9. Select a Trim Style



Trimless

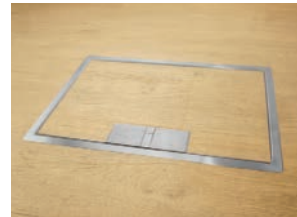

Trim Flange

10. Select Optional Extras



Flat lid (metal top;
no recess)

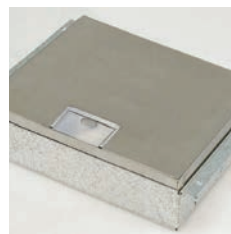

Extra strength lid



IP65 when not in
use

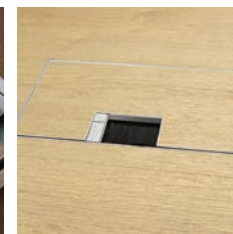

Brush cable exit



Mousehole cable
exit



Lock

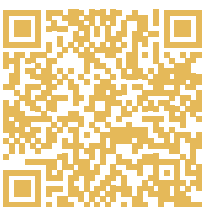

Go to Floor box Chooser online to select the perfect product for your floor box requirements.

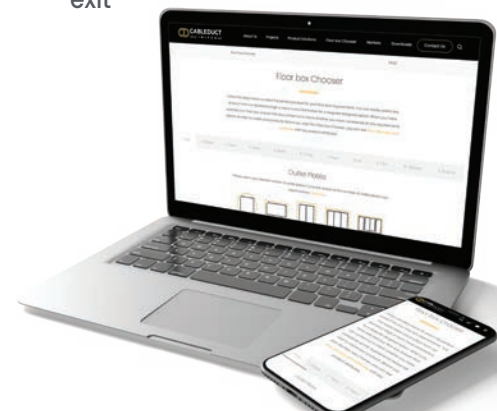

TWO PREMIER FLOOR BOX RANGES

Cableduct's Minima and 700 Series floor boxes are setting new standards in premium floor box solutions.

Our commitment to superior engineering and thoughtful design delivers unmatched quality and sophistication for your projects.

What sets apart our floor boxes?

- Nearly invisible floor boxes with very little metal showing.
- Customised lid-recess depth to suit your floor covering.
- Hand finished lid in stainless steel or brass, with special finishes including bronzing, powder coating and mirror polishing.
- Heavy-duty and discreet solid cast handle and outlet flap.
- Welded and dressed seams for added strength and smooth continuous lines.
- Rectangular, square or round as standard, with bespoke shapes available including diamond and parallelogram.



MINIMA

- Contemporary unbranded design.
- Patented spring-closed handle & flaps keep lid fully flush with floor.
- Two cable exit flaps give more space for leads exiting larger square and rectangular floor boxes.



700 Series

- Classic design with discreet CD logo.
- Elegant look with smooth rounded edges to outlet flap & handle.

MINIMA CONTEMPORARY DESIGNER FLOOR BOX

Contemporary, Unbranded, Solid-cast handle & flaps, Made-to-order, Discreet

For a sleek contemporary finish, the Minima floor box is the perfect choice. Compatible with an extensive range of accessories and with spring-closed outlets, it will ensure that any habitable space is aesthetically attractive and safe from loose cables and wires. The perfect choice for stylish protection against trailing leads.



MINIMA (cont.)

SHAPE



Rectangular **(as standard)**

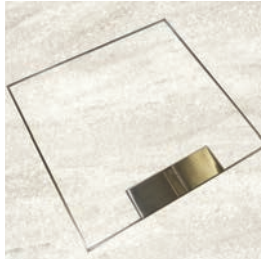

Square **(as standard)**



Round **(as standard)**

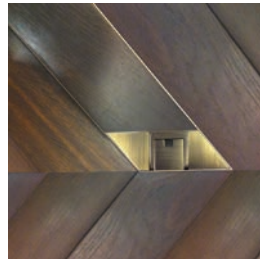

Bespoke

FINISH

Standard Finishes



Brass-Satin

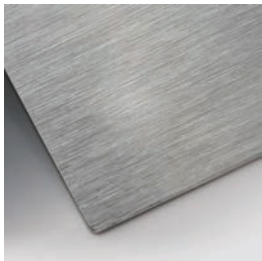

Stainless Steel-Satin

Special Finishes

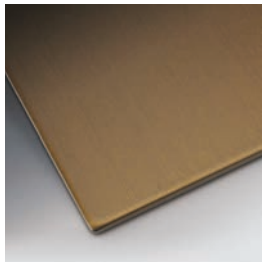

Antique Bronze
lacquer finish

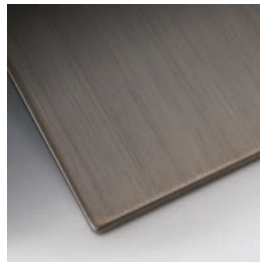

Jordan Bronze
lacquer finish

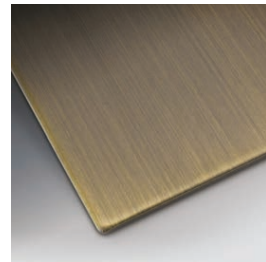

Antique Brass
lacquer finish

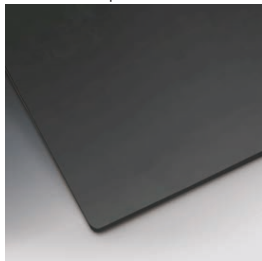

Powdercoat finish to most
RAL colours, including:
Bronze, Black

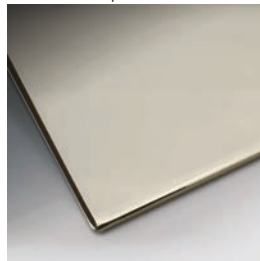

Mirror polished stainless
steel

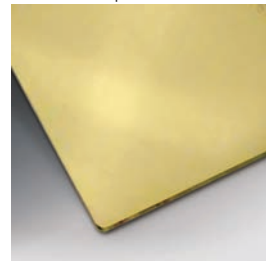

Mirror polished brass

OPTIONS



Lock



Mousehole cable exit

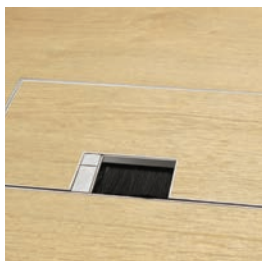

Brush cable exit

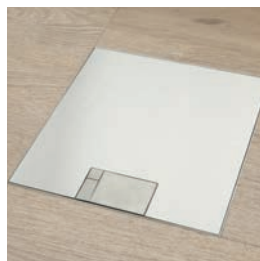

Flat lid (metal top; no
recess)



Extra strength lid



Retrofit

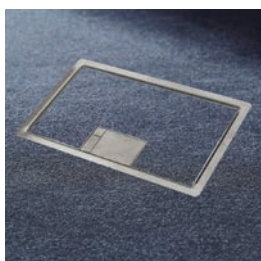

Trim Flange

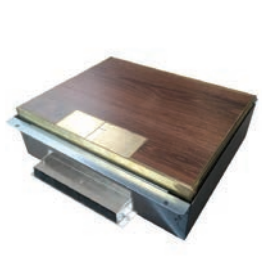

Spigot for in screed
trunking



IP65 when not in use

RECTANGULAR/STANDARD ASSEMBLY

Product Name	No. of compartments/ outlet plates	Base box depth (mm)	Plug top space - max (fixed) (mm)	Base box size (mm)	Lid-Frame size (mm)	Feed type	Recess: Min-Max (mm)
		A	B	C1 x C2	D	E	F
MIN-M16C	1	65	28	260x158	250x148	Conduit / Trunking - In screed	10-30
MIN-M18C	1	85	28	260x158	250x148		3-30
MIN-M12C	1	120	68	260x158	250x148		3-30
MIN-M26C	2	65	28	243x260	233x250		10-30
MIN-M28C	2	85	28	243x260	233x250		3-30
MIN-M22C	2	120	68	243x260	233x250		3-30
MIN-M36C	3	65	28	330x260	320x250		10-30
MIN-M38C	3	85	28	330x260	320x250		3-30
MIN-M32C	3	120	68	330x260	320x250		3-30
MIN-M46C	4	65	28	417x260	407x250		10-30
MIN-M48C	4	85	28	417x260	407x250		3-30
MIN-M42C	4	120	68	417x260	407x250		3-30

SQUARE/STANDARD ASSEMBLY

Product Name	No. of compartments/ outlet plates	Base box depth (mm)	Plug top space - max (fixed) (mm)	Base box size (mm)	Lid-Frame size (mm)	Feed type	Recess: Min-Max (mm)
		A	B	C1 x C2	D	E	F
MIN-MS6C	1	65	28	160x160	150x150	Conduit	10-30
MIN-MS8C	1	85	28	160x160	150x150		3-30
MIN-MS2C	1	120	68	160x160	150x150		3-30
MIN-MM6C	2	65	28	210x210	200x200	Conduit / Trunking - In screed	10-30
MIN-MM8C	2	85	28	210x210	200x200		3-30
MIN-MM2C	2	120	68	210x210	200x200		3-30
MIN-M06C	3	65	28	310x310	300x300		10-30
MIN-M08C	3	85	28	310x310	300x300		3-30
MIN-M02C	3	120	68	310x310	300x300		3-30

MINIMA (cont.)

DRAWINGS - RECTANGULAR/SQUARE/STANDARD ASSEMBLY

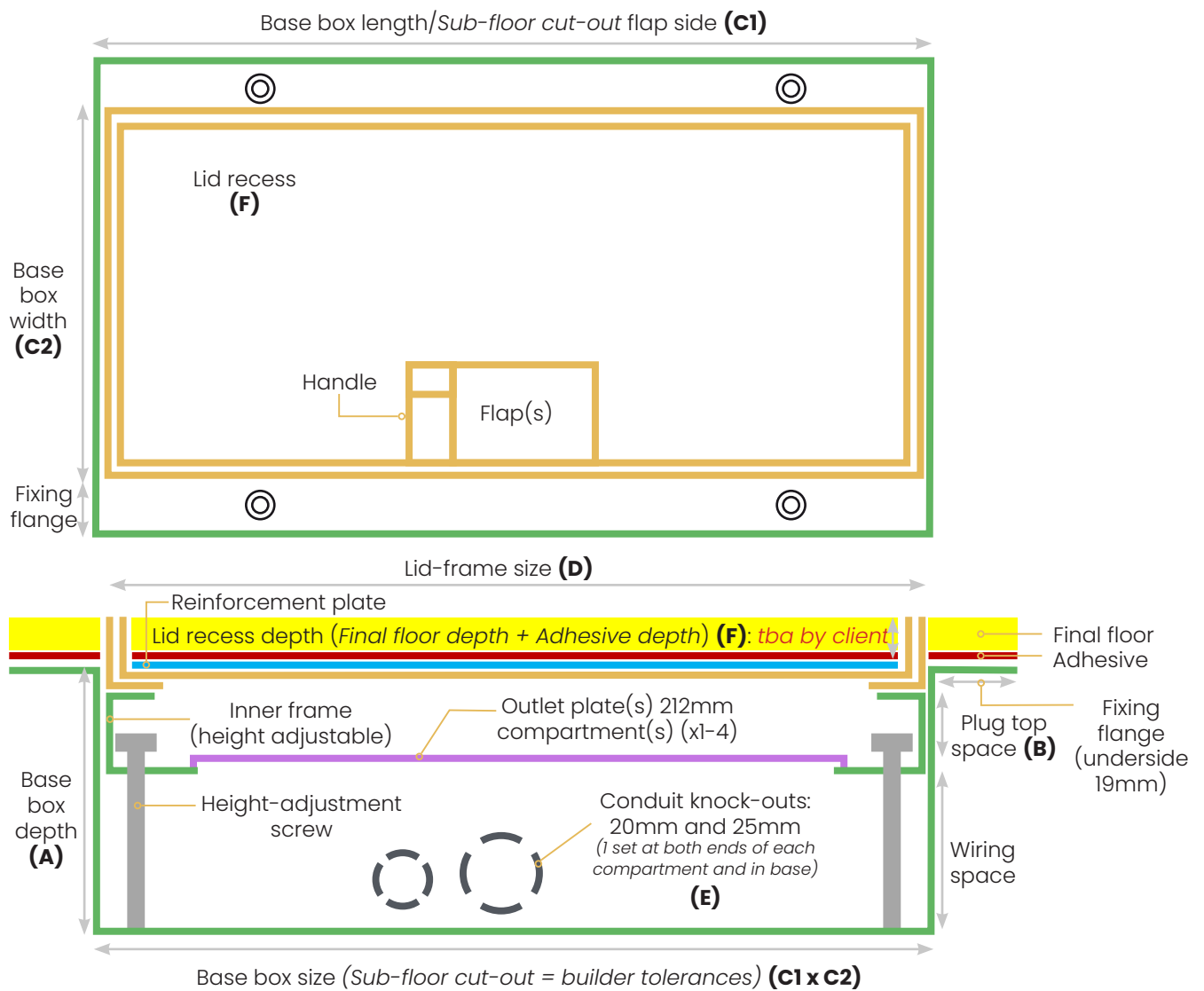

KEY

Item	Material/Thickness
First fix items	
Base box and Inner-frame	1.2mm and 1.5mm
Outlet plate(s)/ compartment(s) x1-4	1.2mm
Second fix items	
Lid and Lid-frame	1.5mm
Reinforcement plate	2mm

Please note:
 Drawings are not to scale and are only representative. Dimensions and installation criteria are indicative only and remain the customer's responsibility.

(Rectangular, trimless shown)

RECTANGULAR/RETROFIT

Product Name	No. of compartments/ outlet plates	Base box set-up (mm deep)	Plug top space - max (fixed) (mm)	Base box size (mm)	Lid-Frame size (mm)	Feed type	Recess: Min-Max (mm)
		A	B	C1 x C2	D	E	F
MIN-M16C	1	65	28	250x148	250x148	Conduit / Trunking - In screed	3-30
MIN-M18C	1	85	28	250x148	250x148		3-30
MIN-M12C	1	120	68	250x148	250x148		3-30
MIN-M26C	2	65	28	233x250	233x250		3-30
MIN-M28C	2	85	28	233x250	233x250		3-30
MIN-M22C	2	120	68	233x250	233x250		3-30
MIN-M36C	3	65	28	320x250	320x250		3-30
MIN-M38C	3	85	28	320x250	320x250		3-30
MIN-M32C	3	120	68	320x250	320x250		3-30
MIN-M46C	4	65	28	407x250	407x250		3-30
MIN-M48C	4	85	28	407x250	407x250		3-30
MIN-M42C	4	120	68	407x250	407x250		3-30

SQUARE/RETROFIT

Product Name	No. of compartments/ outlet plates	Base box set-up (mm deep)	Plug top space - max (fixed) (mm)	Base box size (mm)	Lid-Frame size (mm)	Feed type	Recess: Min-Max (mm)
		A	B	C1 x C2	D	E	F
MIN-MS6C	1	65	28	150x150	150x150	Conduit	3-30
MIN-MS8C	1	85	28	150x150	150x150		3-30
MIN-MS2C	1	120	68	150x150	150x150		3-30
MIN-MM6C	2	65	28	200x200	200x200	Conduit / Trunking - In screed	3-30
MIN-MM8C	2	85	28	200x200	200x200		3-30
MIN-MM2C	2	120	68	200x200	200x200		3-30
MIN-M06C	3	65	28	300x300	300x300		3-30
MIN-M08C	3	85	28	300x300	300x300		3-30
MIN-M02C	3	120	68	300x300	300x300		3-30

MINIMA (cont.)

DRAWINGS - RECTANGULAR/SQUARE/RETROFIT

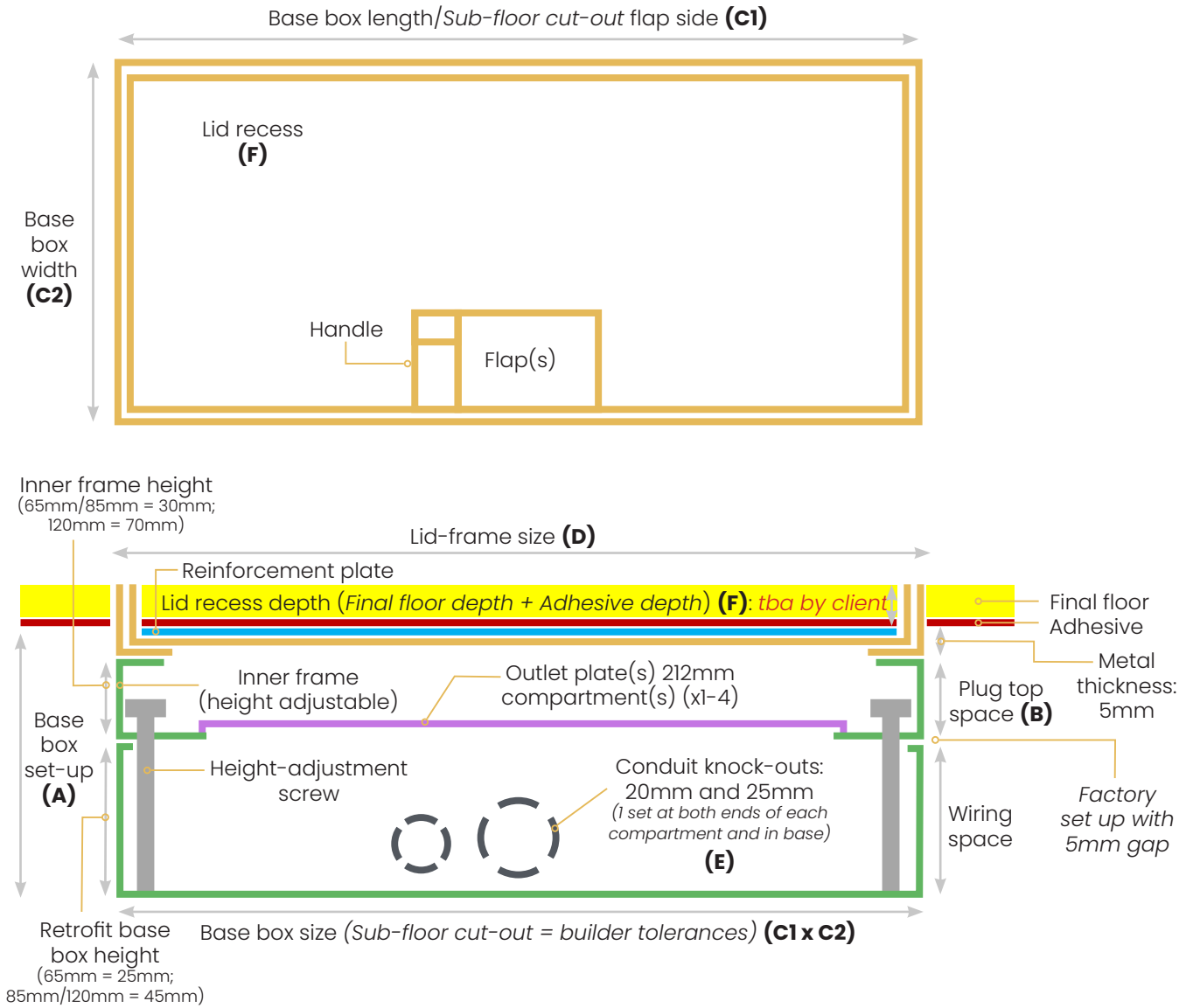

KEY

- █ Base box (1.2mm) and Inner-frame (1.5mm)
- █ Outlet plate(s)/ compartment(s) x1-4 (1.2mm)
- █ Lid and Lid-frame (1.5mm)
- █ Reinforcement plate (2mm)

Please note:

Drawings are not to scale and are only representative. Dimensions and installation criteria are indicative only and remain the customer's responsibility.

(Rectangular, trimless shown)

ROUND/STANDARD ASSEMBLY

Product Name	No. of compartments/ outlet plates	Base box depth (mm)	Plug top space - max (fixed) (mm)	Base box size (mm)	Lid-Frame size (mm)	Feed type	Recess: Min-Max (mm)
		A	B	C1 x C2	D	E	F
MIN-RS6S	1	65	28	160x160	127	Conduit	15-30
MIN-RS8S	1	85	38	160x160	127		3-30
MIN-RS2S	1	120	68	160x160	127		3-30
MIN-RM6S	1	65	28	210x210	169		15-30
MIN-RM8S	1	85	38	210x210	169		3-30
MIN-RM2S	1	120	68	210x210	169		3-30
MIN-RO8S	2	85	38	260x243	193	Conduit / Trunking - In screed	3-30
MIN-RO2S	2	120	68	260x243	193		3-30
MIN-RL6S	3	65	28	310x310	289		15-30
MIN-RL8S	3	85	28	310x310	289		3-30
MIN-RL2S	3	120	68	310x310	289		3-30

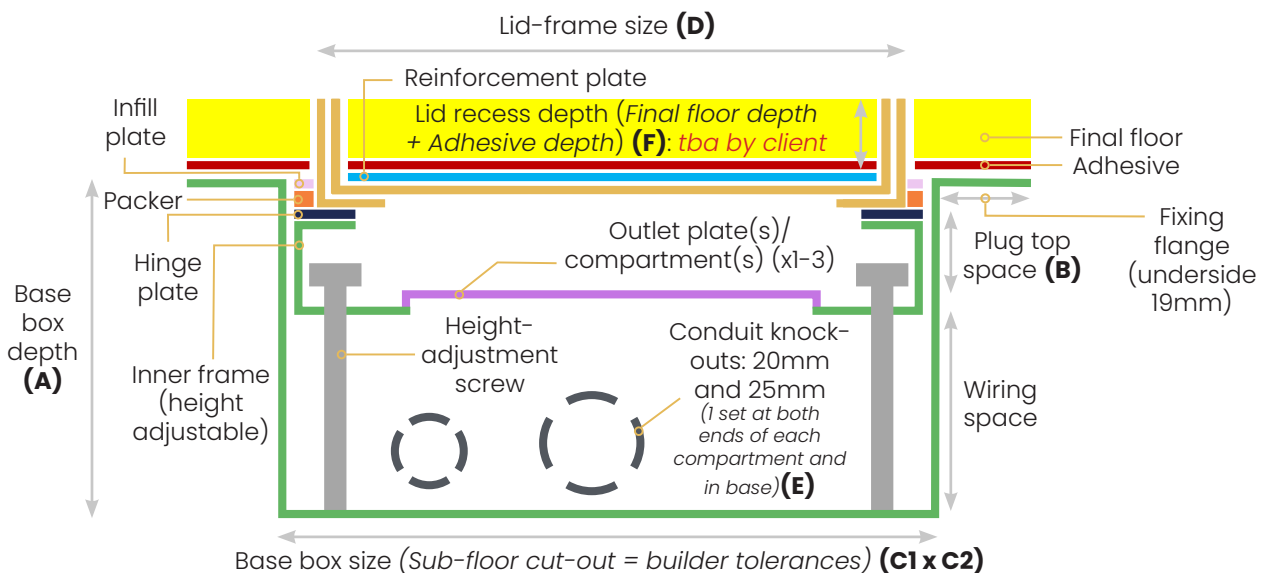
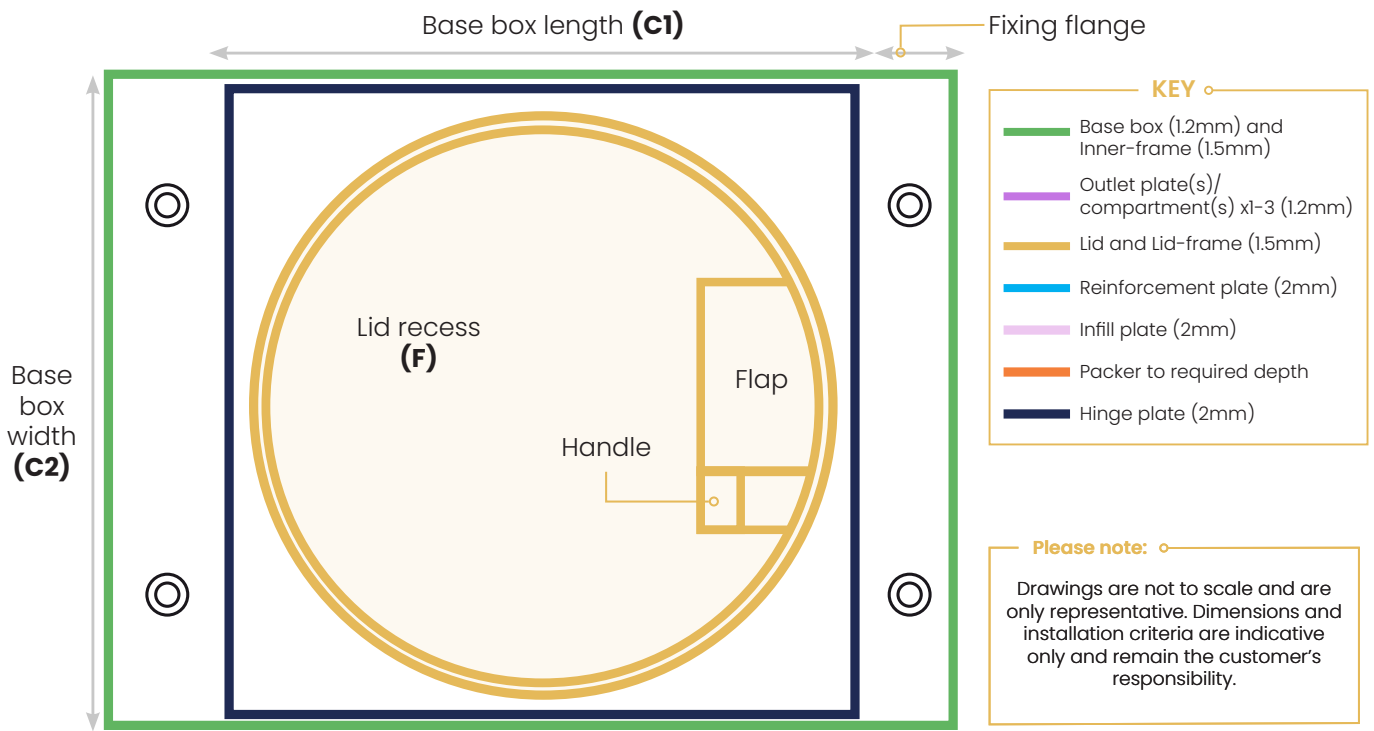

ROUND/RETROFIT

Product Name	No. of compartments/ outlet plates	Base box set-up (mm deep)	Plug top space - max (fixed) (mm)	Base box size (mm)	Lid-Frame size (mm)	Feed type	Recess: Min-Max (mm)
		A	B	C1 x C2	D	E	F
MIN-RS6R	1	65	28	127x127	127	Conduit	3-30
MIN-RS8R	1	85	38	127x127	127		3-30
MIN-RS2R	1	120	68	127x127	127		3-30
MIN-RM8R	1	85	33	169x169	169		3-30
MIN-RM2R	1	120	68	169x169	169		3-30
MIN-RO8R	2	85	38	193x193	193		3-30
MIN-RO2R	2	120	68	193x193	193		3-30
MIN-RL6R	3	65	28	289x289	289		3-30
MIN-RL8R	3	85	28	289x289	289		3-30
MIN-RL2R	3	120	68	289x289	289		3-30

Base box length (**C1**)

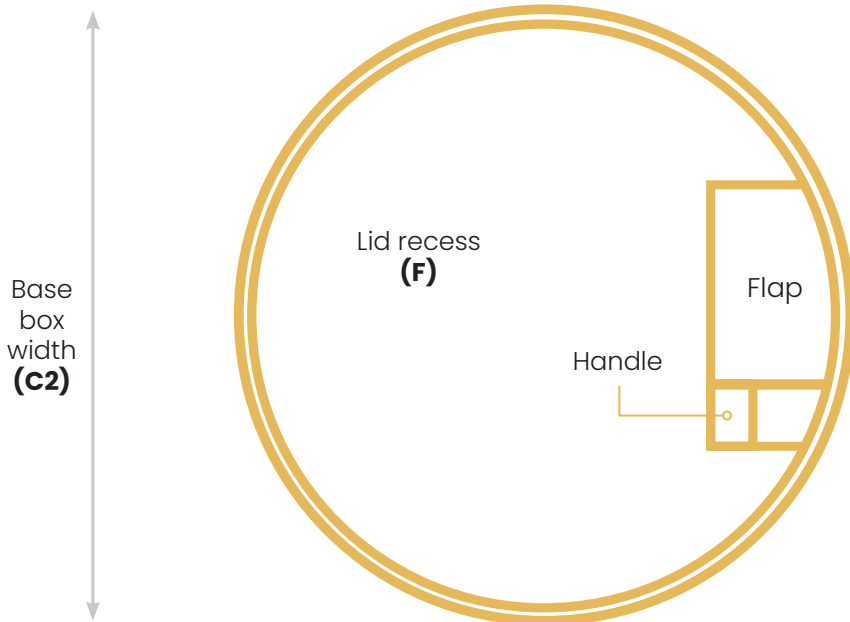

KEY

- █ Base box (1.2mm) and Inner-frame (1.5mm)
- █ Outlet plate(s)/ compartment(s) x1-3 (1.2mm)
- █ Lid and Lid-frame (1.5mm)
- █ Reinforcement plate (2mm)
- █ Hinge plate (2mm)

Please note:

Drawings are not to scale and are only representative. Dimensions and installation criteria are indicative only and remain the customer's responsibility.

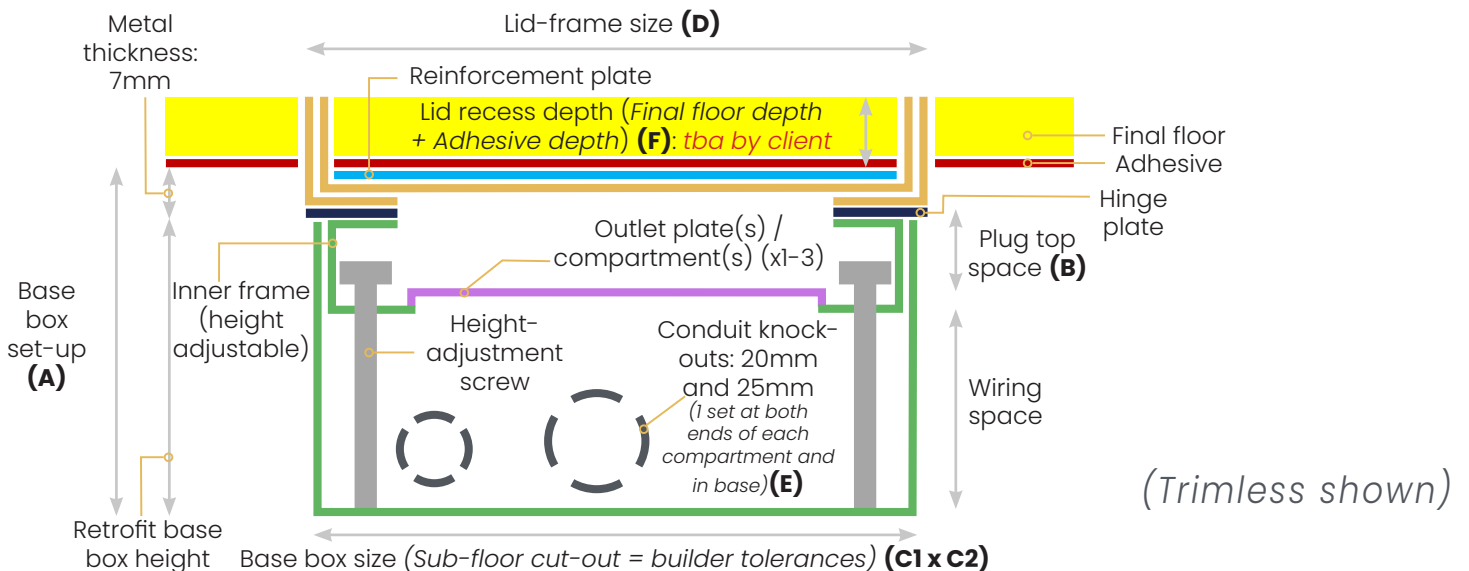

(Trimless shown)

700 SERIES CLASSIC AND ELEGANT FLOOR BOX

Classic, With CD logo, Solid-cast handle & flap, Made-to-order, Discreet

The 700 series floor box is designed to create a stylish heritage aesthetic. Featuring a retro-style cable opening function with pull-up handle, it is discreet and understated and suitable for all types of residential and commercial installations. It is often specified for use in timber floored offices where a multi-outlet floor box is required.



700 SERIES (cont.)

SHAPE



Rectangular **(as standard)**



Square **(as standard)**



Round **(as standard)**

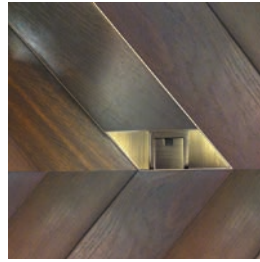

Bespoke

FINISH

Standard Finishes



Brass-Satin

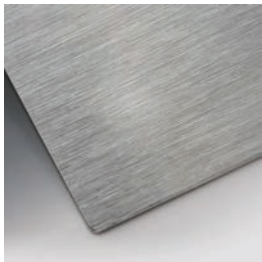

Stainless Steel-Satin

Special Finishes

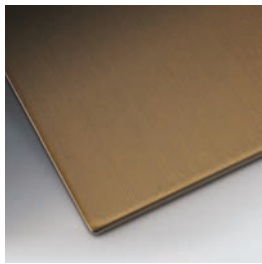

Antique Bronze
lacquer finish

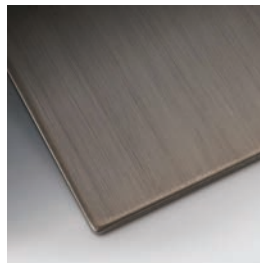

Jordan Bronze
lacquer finish

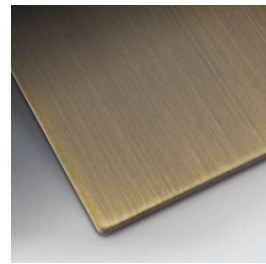

Antique Brass
lacquer finish

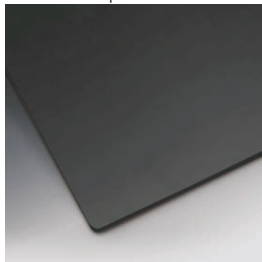

Powdercoat finish to most
RAL colours, including:
Bronze, Black

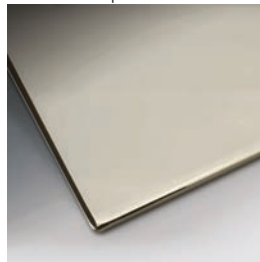

Mirror polished stainless
steel

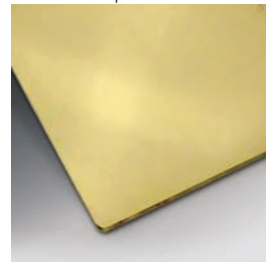

Mirror polished brass

OPTIONS



Lock



Mousehole cable exit



Flat lid (metal top; no
recess)



Extra strength lid



Retrofit



Trim Flange
(Rectangular shown)

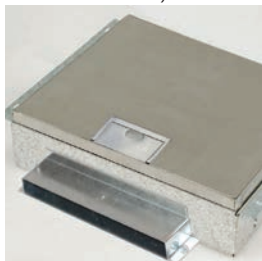

Spigot for in screed
trunking



IP65 when not in use

RECTANGULAR/STANDARD ASSEMBLY

Product Name	No. of compartments/ outlet plates	Base box depth (mm)	Plug top space - max (fixed) (mm)	Base box size (mm)	Lid-Frame size (mm)	Feed type	Recess: Min-Max (mm)
		A	B	C1 x C2	D	E	F
SBOX-716	1	65	28	260x158	250x148	Conduit / Trunking - In screed	10-30
SBOX-718	1	85	28	260x158	250x148		3-30
SBOX-712	1	120	68	260x158	250x148		3-30
SBOX-726	2	65	28	243x260	233x250		10-30
SBOX-728	2	85	28	243x260	233x250		3-30
SBOX-722	2	120	68	243x260	233x250		3-30
SBOX-736	3	65	28	330x260	320x250		10-30
SBOX-738	3	85	28	330x260	320x250		3-30
SBOX-732	3	120	68	330x260	320x250		3-30
SBOX-746	4	65	28	417x260	407x250		10-30
SBOX-748	4	85	28	417x260	407x250		3-30
SBOX-742	4	120	68	417x260	407x250		3-30

SQUARE/STANDARD ASSEMBLY

Product Name	No. of compartments/ outlet plates	Base box depth (mm)	Plug top space - max (fixed) (mm)	Base box size (mm)	Lid-Frame size (mm)	Feed type	Recess: Min-Max (mm)
		A	B	C1 x C2	D	E	F
SBOX-7S6	1	65	28	160x160	150x150	Conduit	10-30
SBOX-7S8	1	85	28	160x160	150x150		3-30
SBOX-7S2	1	120	68	160x160	150x150		3-30
SBOX-7M6	2	65	28	210x210	200x200	Conduit / Trunking - In screed	10-30
SBOX-7M8	2	85	28	210x210	200x200		3-30
SBOX-7M2	2	120	68	210x210	200x200		3-30
SBOX-706	3	65	28	310x310	300x300		10-30
SBOX-708	3	85	28	310x310	300x300		3-30
SBOX-702	3	120	68	310x310	300x300		3-30

700 SERIES (cont.)

DRAWINGS - RECTANGULAR/SQUARE/STANDARD ASSEMBLY

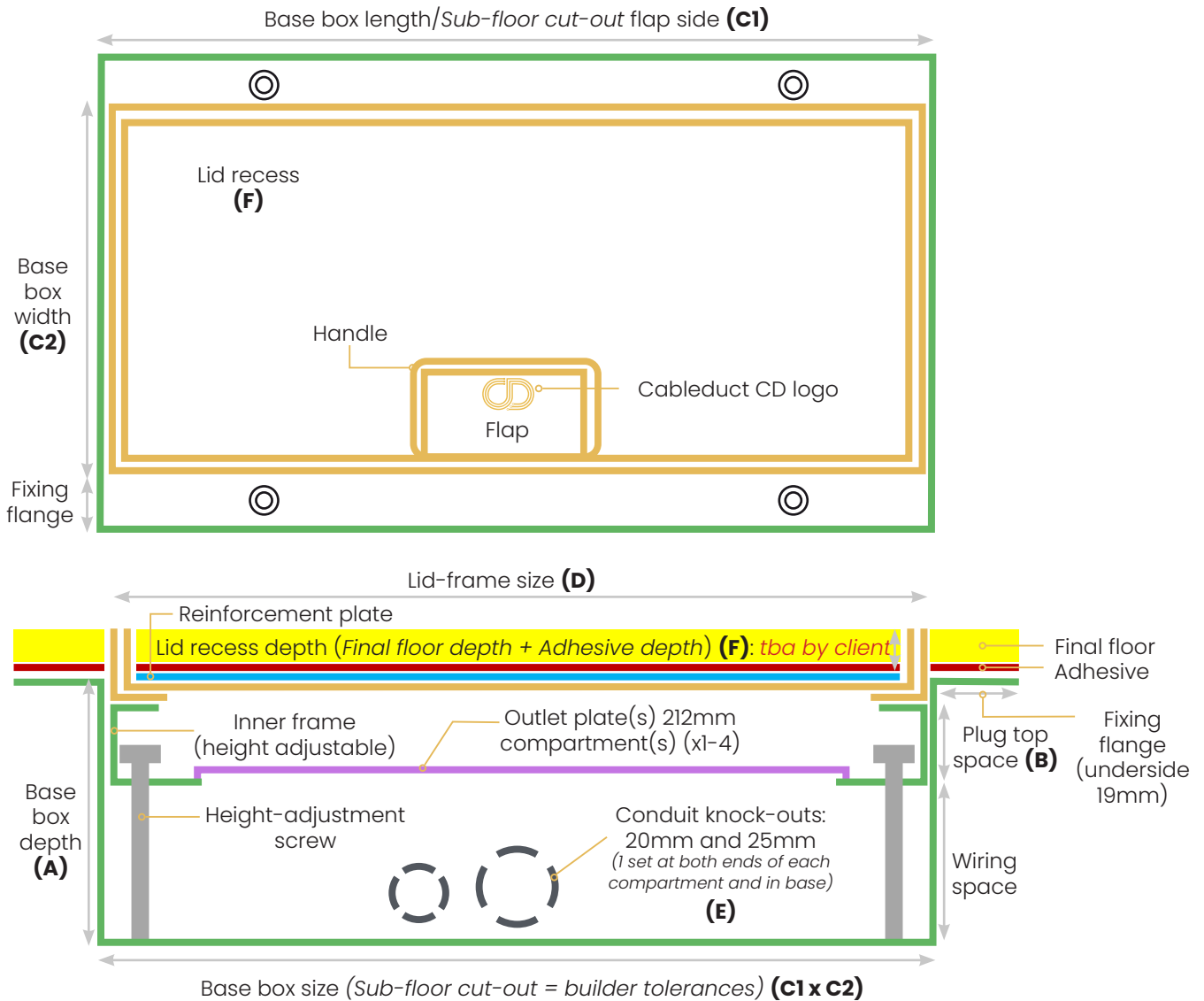

KEY

Item	Thickness
First fix items	
Base box (1.2mm) and Inner-frame (1.5mm)	
Outlet plate(s)/ compartment(s) x1-4 (1.2mm)	
Second fix items	
Lid and Lid-frame (1.5mm)	
Reinforcement plate (2mm)	

Please note:

Drawings are not to scale and are only representative. Dimensions and installation criteria are indicative only and remain the customer's responsibility.

(Rectangular, trimless shown)

RECTANGULAR/RETROFIT

Product Name	No. of compartments/ outlet plates	Base box set-up (mm deep)	Plug top space - max (fixed) (mm)	Base box size (mm)	Lid-Frame size (mm)	Feed type	Recess: Min-Max (mm)
		A	B	C1 x C2	D	E	F
SBOX-716	1	65	28	250x148	250x148	Conduit / Trunking - In screed	3-30
SBOX-718	1	85	28	250x148	250x148		3-30
SBOX-712	1	120	68	250x148	250x148		3-30
SBOX-726	2	65	28	233x250	233x250		3-30
SBOX-728	2	85	28	233x250	233x250		3-30
SBOX-722	2	120	68	233x250	233x250		3-30
SBOX-736	3	65	28	320x250	320x250		3-30
SBOX-738	3	85	28	320x250	320x250		3-30
SBOX-732	3	120	68	320x250	320x250		3-30
SBOX-746	4	65	28	407x250	407x250		3-30
SBOX-748	4	85	28	407x250	407x250		3-30
SBOX-742	4	120	68	407x250	407x250		3-30

SQUARE/RETROFIT

Product Name	No. of compartments/ outlet plates	Base box set-up (mm deep)	Plug top space - max (fixed) (mm)	Base box size (mm)	Lid-Frame size (mm)	Feed type	Recess: Min-Max (mm)
		A	B	C1 x C2	D	E	F
SBOX-7S6	1	65	28	150x150	150x150	Conduit	3-30
SBOX-7S8	1	85	28	150x150	150x150		3-30
SBOX-7S2	1	120	68	150x150	150x150		3-30
SBOX-7M6	2	65	28	200x200	200x200	Conduit / Trunking - In screed	3-30
SBOX-7M8	2	85	28	200x200	200x200		3-30
SBOX-7M2	2	120	68	200x200	200x200		3-30
SBOX-706	3	65	28	300x300	300x300		3-30
SBOX-708	3	85	28	300x300	300x300		3-30
SBOX-702	3	120	68	300x300	300x300		3-30

700 SERIES (cont.)

DRAWINGS - RECTANGULAR/SQUARE/RETROFIT

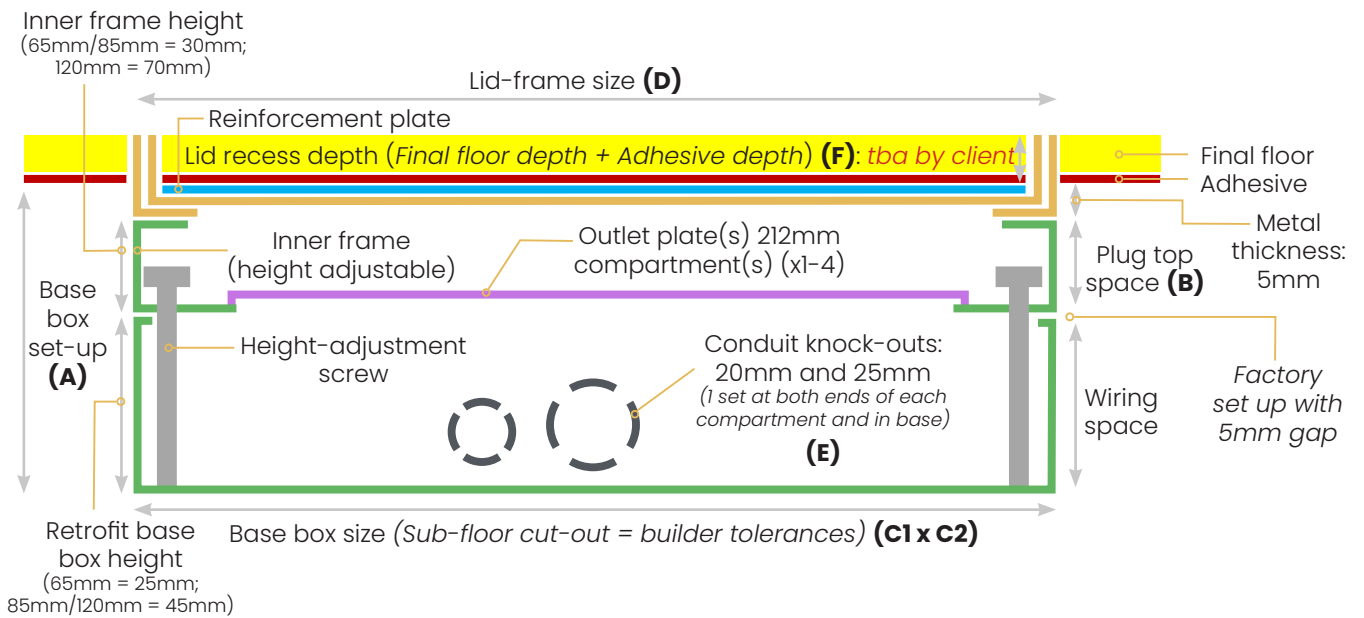
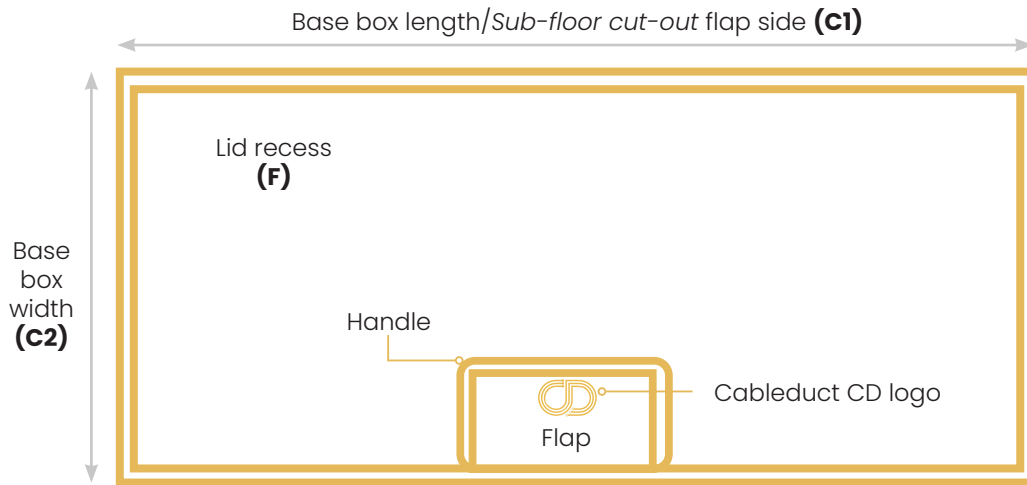

KEY

	Base box (1.2mm) and Inner-frame (1.5mm)
	Outlet plate(s)/ compartment(s) x1-4 (1.2mm)
	Lid and Lid-frame (1.5mm)
	Reinforcement plate (2mm)

Please note:

Drawings are not to scale and are only representative. Dimensions and installation criteria are indicative only and remain the customer's responsibility.

(Rectangular, trimless shown)

ROUND/STANDARD ASSEMBLY

Product Name	No. of compartments/ outlet plates	Base box depth (mm)	Plug top space - max (fixed) (mm)	Base box size (mm)	Lid-Frame size (mm)	Feed type	Recess: Min-Max (mm)
		A	B	C1 x C2	D	E	F
SBOX-7RS-65	1	65	28	160x160	127	Conduit	15-30
SBOX-7RS-85	1	85	38	160x160	127		3-30
SBOX-7RS-120	1	120	68	160x160	127		3-30
SBOX-7RM-65	1	65	28	210x210	169		15-30
SBOX-7RM-85	1	85	38	210x210	169		3-30
SBOX-7RM-120	1	120	68	210x210	169		3-30
SBOX-7RO-85	2	85	38	260x243	193	Conduit / Trunking - In screed	3-30
SBOX-7RO-120	2	120	68	260x243	193		3-30
SBOX-7RL-65	3	65	28	310x310	289		15-30
SBOX-7RL-85	3	85	28	310x310	289	- In screed	3-30
SBOX-7RL-120	3	120	68	310x310	289		3-30

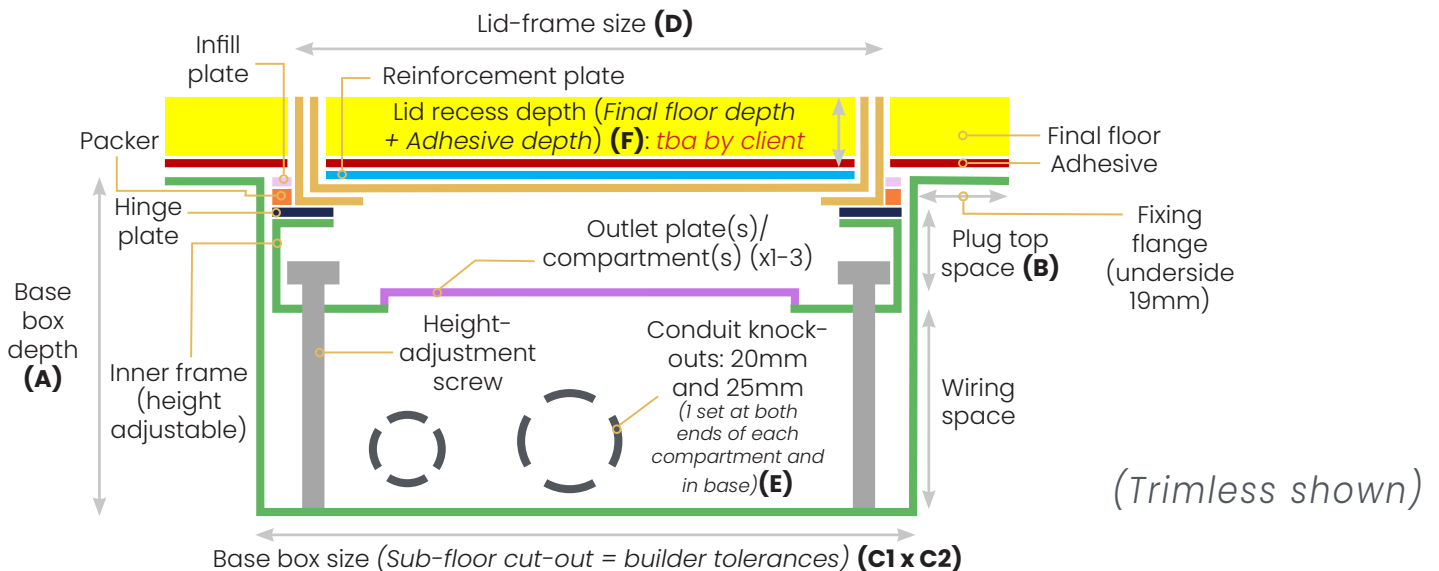
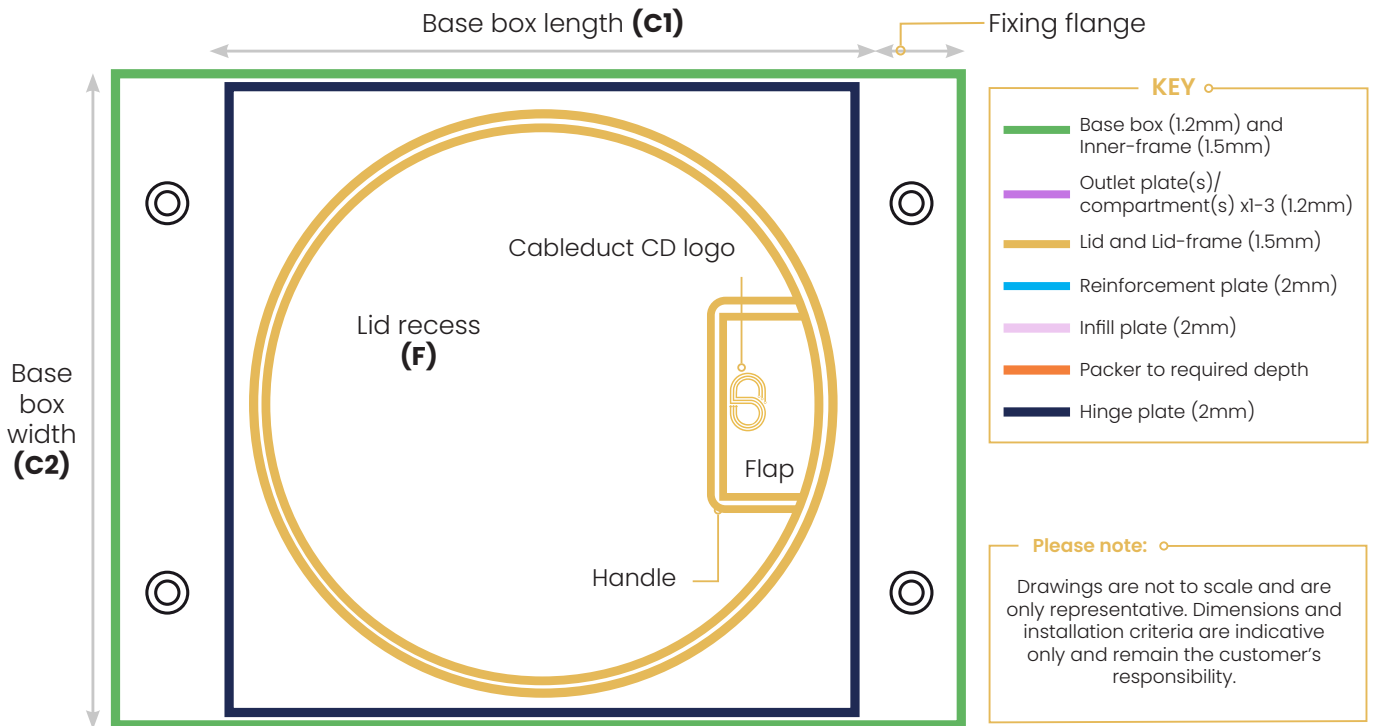

ROUND/RETROFIT

Product Name	No. of compartments/ outlet plates	Base box set-up (mm deep)	Plug top space - max (fixed) (mm)	Base box size (mm)	Lid-Frame size (mm)	Feed type	Recess: Min-Max (mm)
		A	B	C1 x C2	D	E	F
SBOX-7RSR-65	1	65	28	127x127	127	Conduit	3-30
SBOX-7RSR-85	1	85	38	127x127	127		3-30
SBOX-7RSR-120	1	120	68	127x127	127		3-30
SBOX-7RMR-85	1	85	33	169x169	169		3-30
SBOX-7RMR-120	1	120	68	169x169	169		3-30
SBOX-7ROR-85	2	85	38	193x193	193		3-30
SBOX-7ROR-120	2	120	68	193x193	193		3-30
SBOX-7RLR-65	3	65	28	289x289	289		3-30
SBOX-7RLR-85	3	85	28	289x289	289		3-30
SBOX-7RLR-120	3	120	68	289x289	289	3-30	

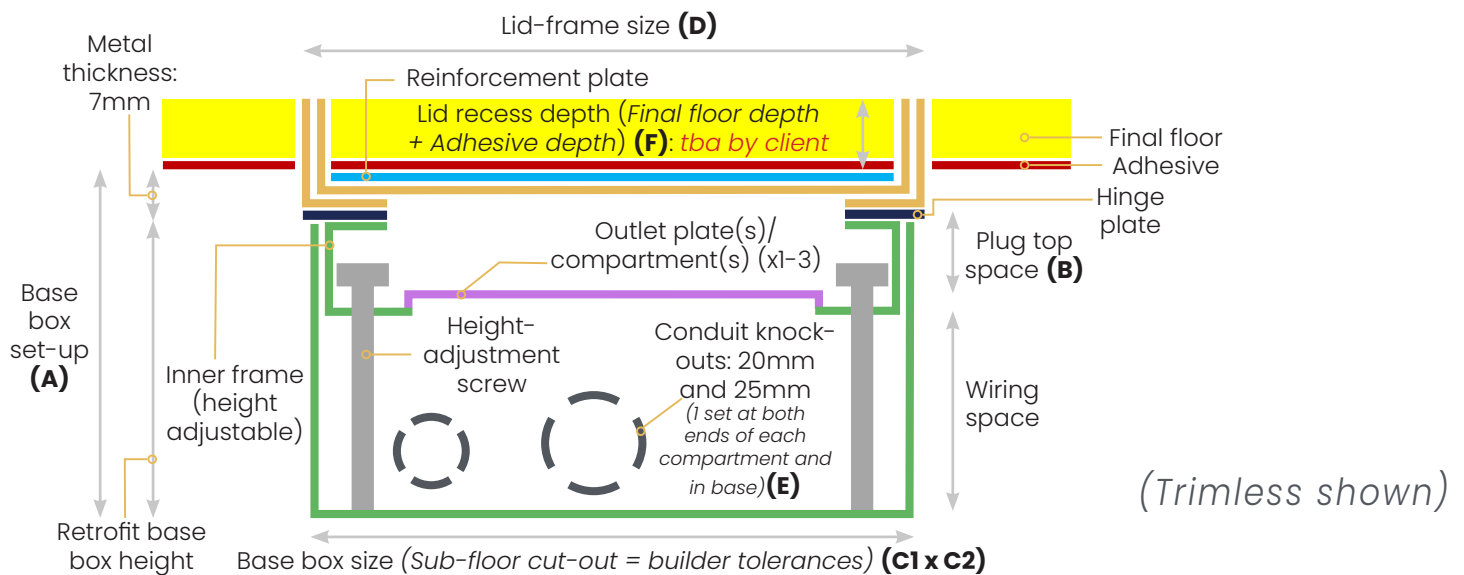
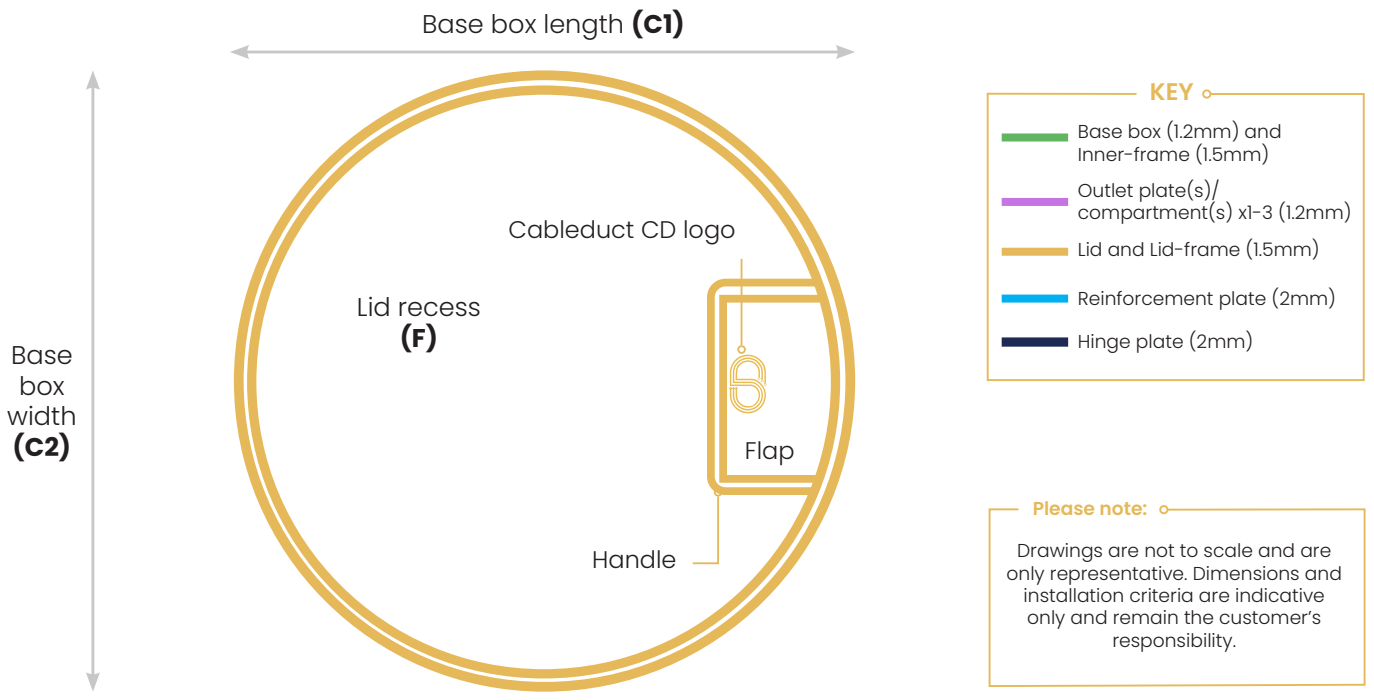

ACCESS GROMMETS FOR ACCESS ONLY

Made-to-Order, Discreet, Metal, Robust, Access only

Access grommets are for access only, no power or data sockets are fitted within the grommet. They are a popular choice for large scale cable containment and distribution. They can be specified in a range of sizes to meet your project requirements. Standard finish is stainless-steel or brass, with optional bronzing and powder-coating available.



ACCESS GROMMETS (cont.)

FINISHES

Standard Finishes



Brass-Satin

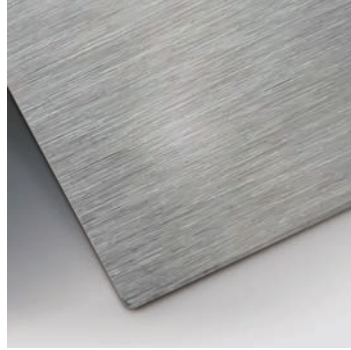

Stainless Steel-Satin

Special Finishes

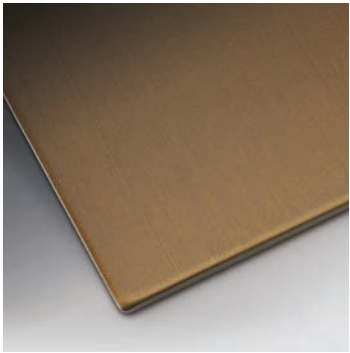

Antique Bronze
lacquer finish

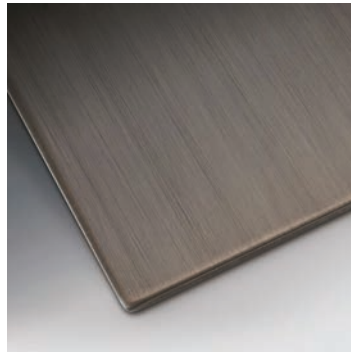

Jordan Bronze
lacquer finish

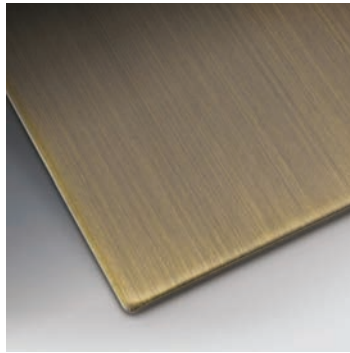

Antique Brass
lacquer finish

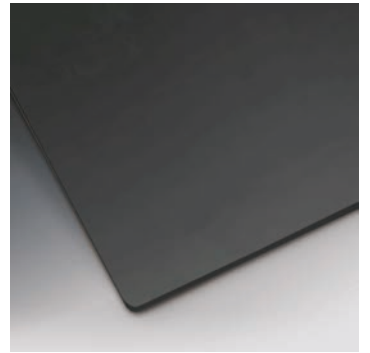

Powdercoat finish to most
RAL colours, including:
Bronze, Black

OPTIONS



Standard access grommet,
trimless

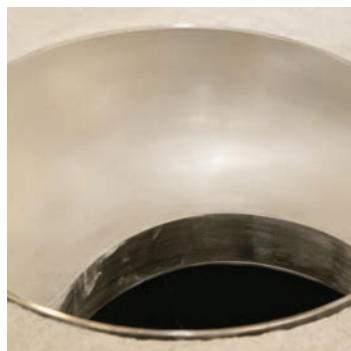

Flat Lid
(metal top; no recess)
(Trimless shown)



Closer
(to cover lid access hole
when access grommet is not
in use and located in areas
with foot traffic)
(Trimless and flat lid shown)

STANDARD ASSEMBLY/TRIMLESS

Product Name	Base box depth (mm)	Cut-out size (mm)	Base box size (mm)	Lid-frame size (mm)	Feed type	Recess: Min-Max (mm)	Lid access hole size: length x width (mm)
	A	A1	C1 x C2	D	E	F	G1 x G2
GROM-RS	65	105x105	160x160	127	Conduit	3-30	100x55
GROM-RO	65	175x192	243x260	193	Conduit	3-30	120x60
GROM-RL	65	240x240	310x310	289	Conduit	3-30	165x73

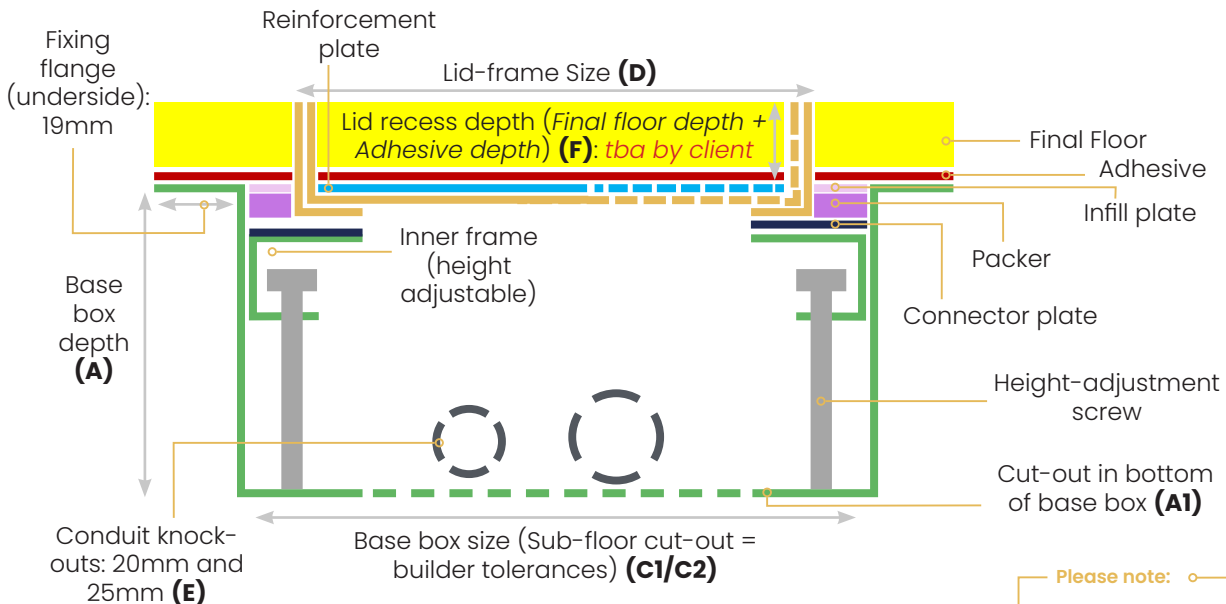
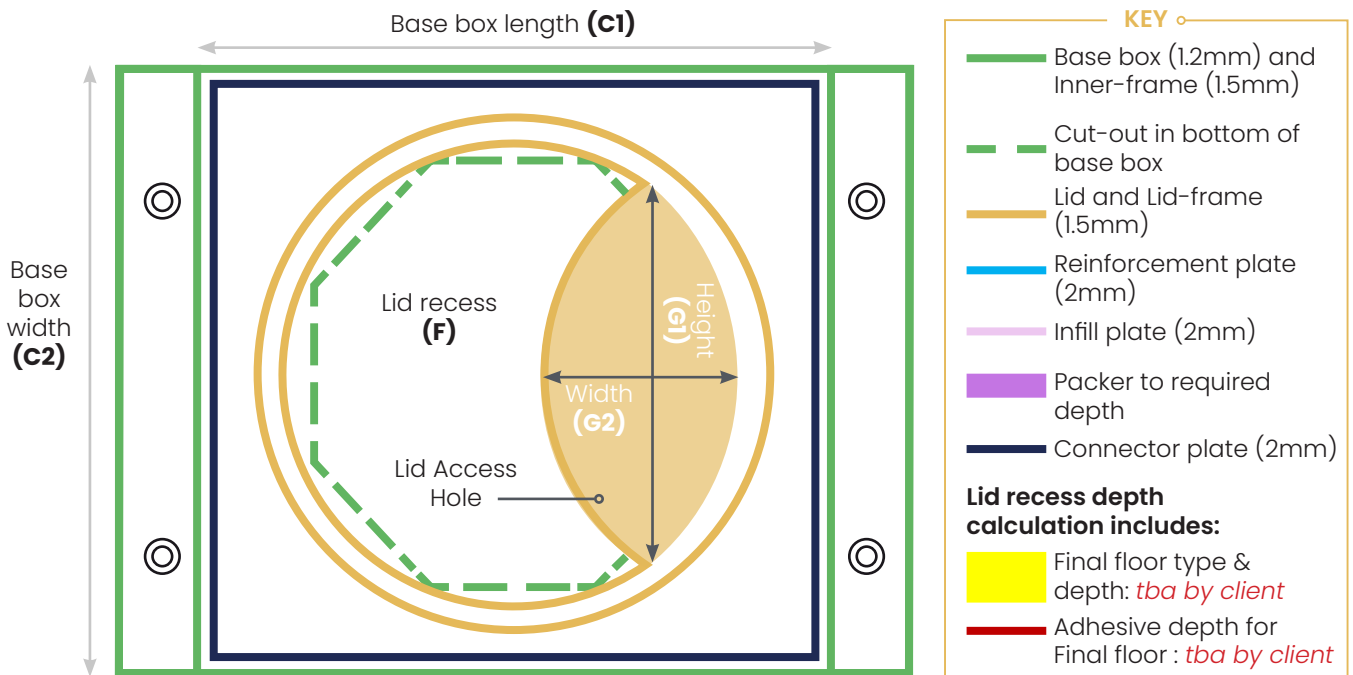

Please note: Drawings are not to scale and are only representative. Dimensions and installation criteria are indicative only and remain the customer's responsibility.

ACCESS GROMMETS (cont.)

RETROFIT/WITH TRIM FLANGE

Product Name	Mounting frame depth (mm)	Cut-out size (at widest; mm)	Lid-frame diameter (mm)	Recess: Min-Max (mm)	Lid access hole size: length x width (mm)
	A	A1	D	F	G1 x G2
GROM-RS R	40	92x72	127	3-30	100x55
GROM-ROR	40	163x121	193	3-30	120x60
GROM-RL R	40	222x140	289	3-30	165x73

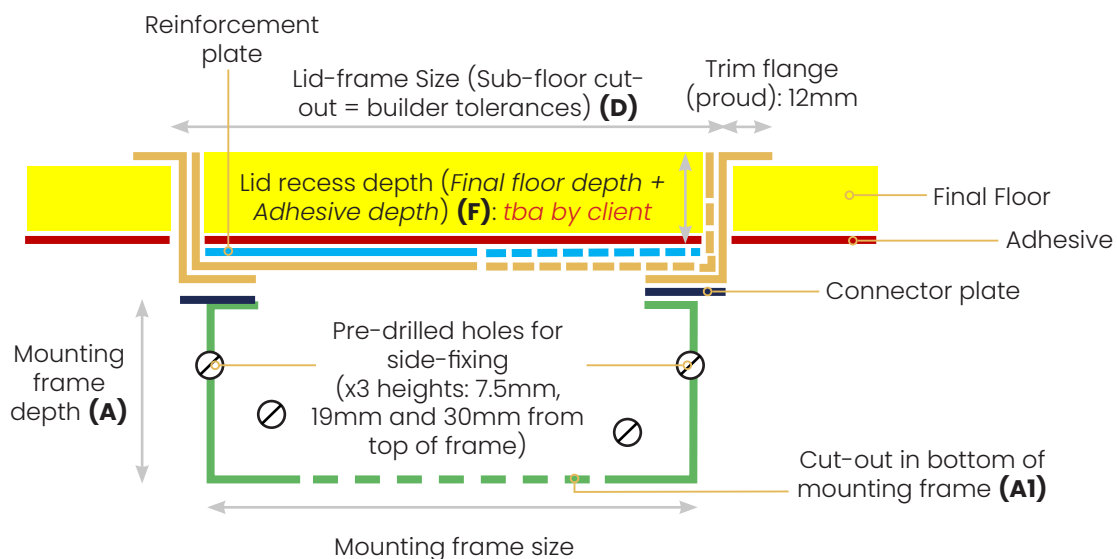
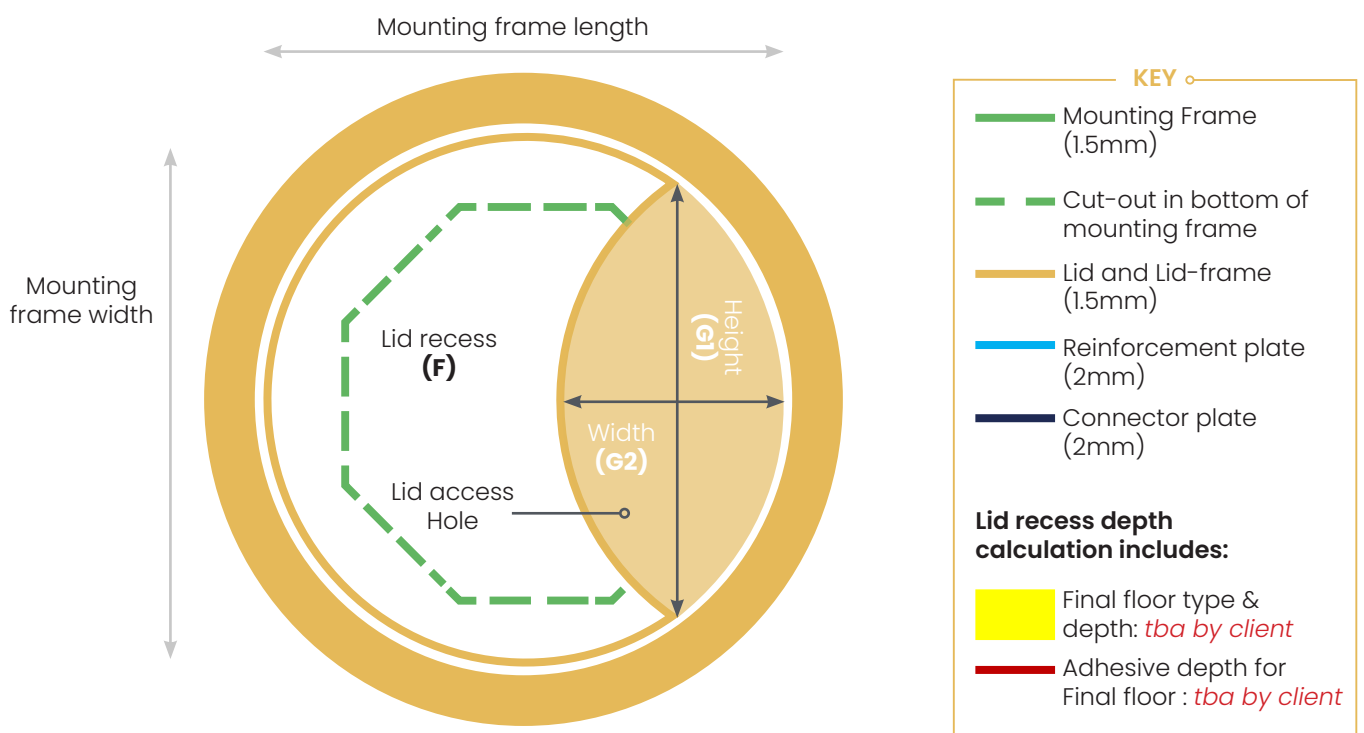

***Please note:** Drawing and cross-section are not to scale and are only representative. Dimensions and installation criteria are indicative only and intended to aid customer planning. Exact installation dimensions and actions remain the customer's responsibility.

500 SERIES SHALLOW FLOOR BOX FOR OFFICES

Shallow, Discreet, Unbranded, Integrated

The 500 series floor box is a versatile cable containment unit available in many sizes. The Lid is trimless in the 500 series floor box's design. It is completely discreet with recessed outlet flaps. It is a popular option for installations in open plan offices and schools and where site conditions and budgets are restricted.

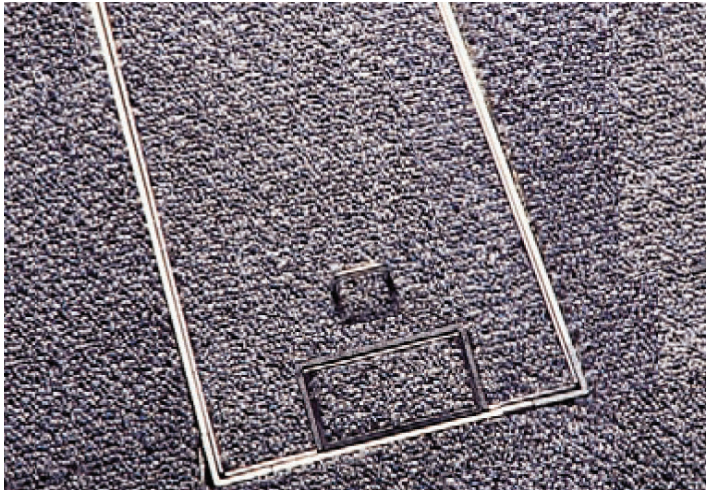
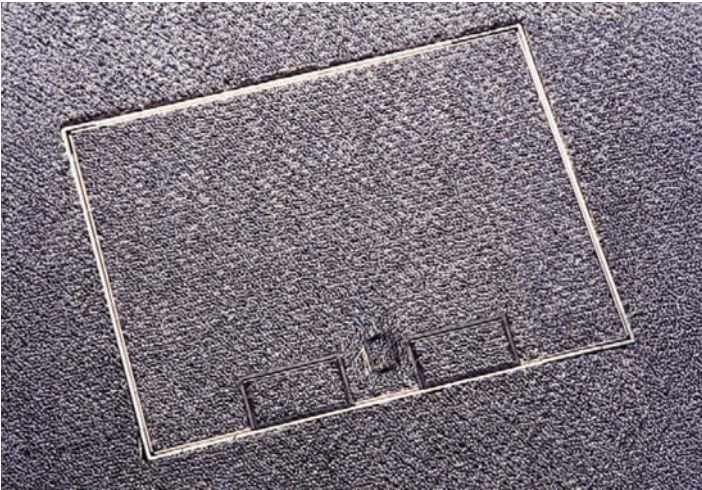
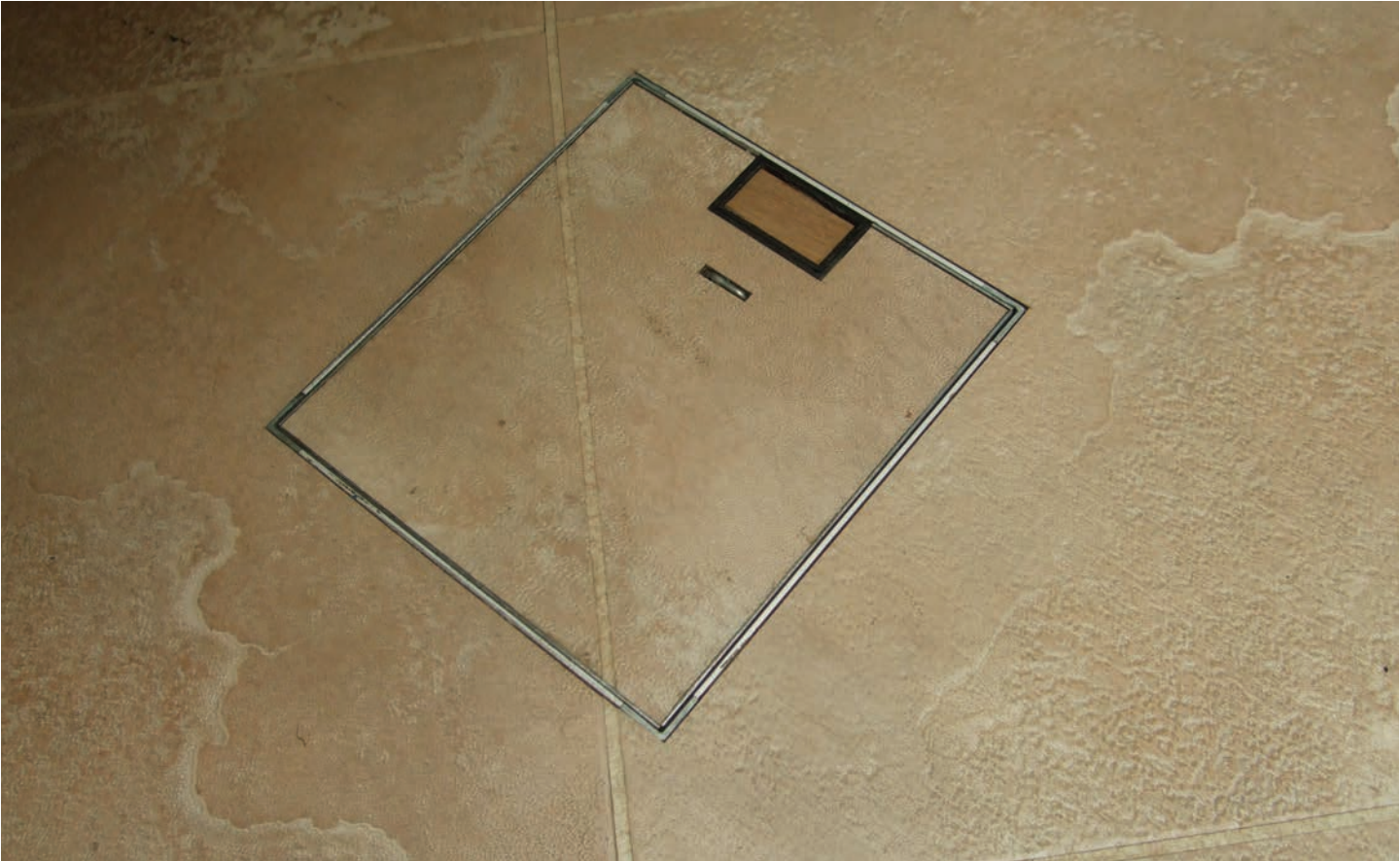

500 SERIES (cont.)

STANDARD ASSEMBLY

Product Name	No. of compartments/ outlet plates	Base box depth (mm)	Plug top space - max (fixed) (mm)	Base box size (mm)	Lid-Frame size (mm)	Feed type	Recess: Fixed (mm)
		A	B	C1 x C2	D	E	F
SBOX-514	1	55	20	132x276	126x230	Conduit	6.5
SBOX-518	1	65	27	132x236	126x230		
SBOX-516	1	85	27	132x236	126x230		
SBOX-512	1	120	27	132x236	126x230		
SBOX-524	2	55	20	219x276	213x230		
SBOX-528	2	65	27	213x236	213x230		
SBOX-526	2	85	27	213x236	213x230		
SBOX-522	2	120	27	213x236	213x230		
SBOX-504	3	55	20	306x276	300x230		
SBOX-508	3	65	27	306x236	300x230		
SBOX-506	3	85	27	306x236	300x230		
SBOX-502	3	120	27	306x236	300x230		
SBOX-544	4	55	20	393x276	387x230		
SBOX-548	4	65	27	393x236	387x230		
SBOX-546	4	85	27	393x236	387x230		
SBOX-542	4	120	27	393x236	387x230		

INTEGRATED WITH TRUNKING

Product Name	No. of compartments/ outlet plates	Base box depth (mm)	Plug top space - max (fixed) (mm)	Base box size (mm)	Lid-Frame size (mm)	Feed type	Recess: Fixed (mm)
		A	B	C1 x C2	D	E	F
SBOX-505-U2/U3	3	55	20	306x276	300x230	Trunking - in screed / integrated	6.5
SBOX-508-U2/U3	3	65	27	306x236	300x230		
SBOX-FF12-502	3	55	20	n/a	300x230	Trunking - flush screed / integrated. No base box and supplied with length of flush floor lid and channel	
SBOX-FF13-503	3	65	27	n/a	300x230		
SBOX-FF15-503	4	65	27	n/a	387x230		

DRAWINGS

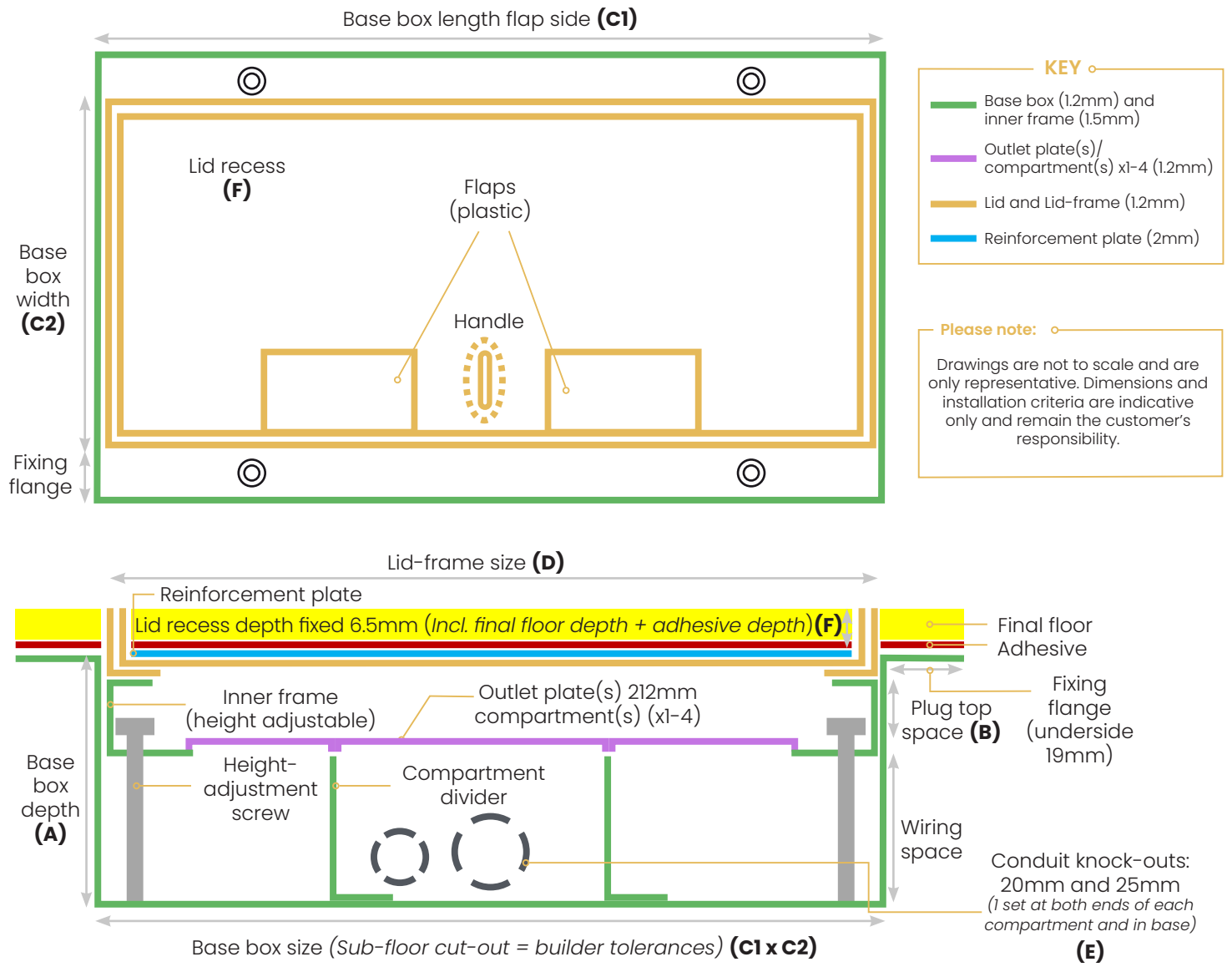

OPTIONS



2000 SERIES PLASTIC FIRE-RETARDANT FLOOR BOX

Discreet, Plastic, Fire-retardant, Integrated

If your project includes carpet-tiled floors in offices, a more generic floor box is all that is needed. Where style and discretion are secondary to functionality and protection, or if a project is time-sensitive and requires numerous floor boxes, the 2000 series floor box is the best option and will not compromise your safety or your interior aesthetic.

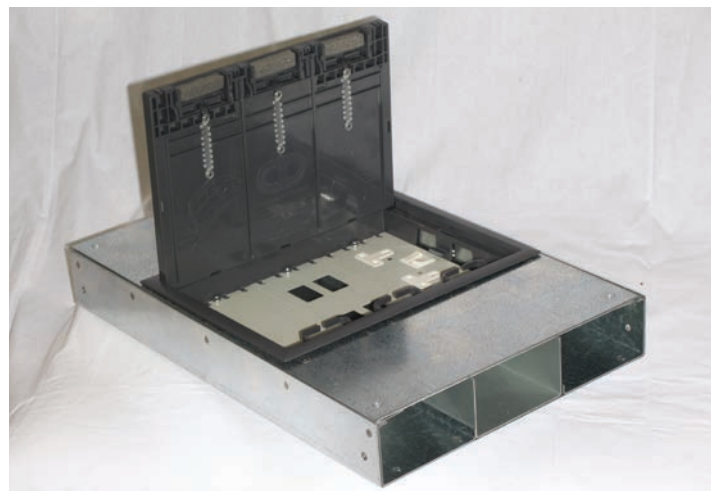
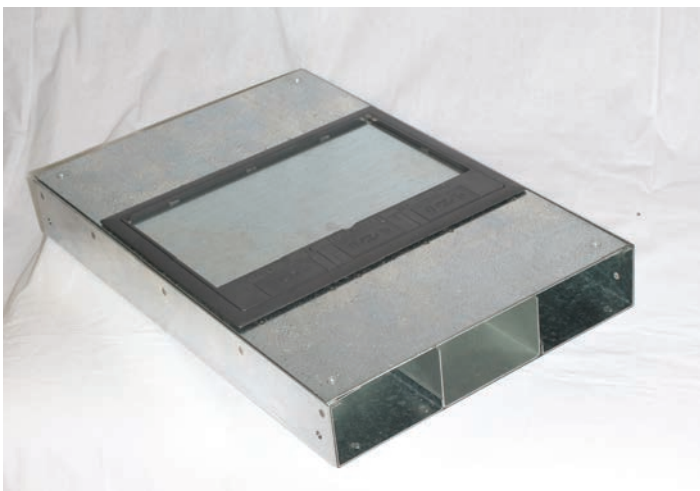

Product Name	No. of compartments/ outlet plates	Base box depth (mm)	Plug top space - max (variable) (mm)	Sub-floor cut-out size (mm)	Lid-Frame size (mm)	Feed type	Recess: Fixed (mm)
		A	B	C1 x C2	D	E	F
SBOX-2355C	3	55	28-31	307x244	300x217	Conduit boot	6
SBOX-2355U3	3	55	28-31	307x244		Trunking - In screed U3 (boot with spigot entry)	
SBOX-2355FF	3	55	28-31	No base box		Trunking - Flush screed FF12 / integrated. No base box and supplied with length of flush floor lid and channel	
SBOX-2365C	3	65	30-34	307x227		Conduit	
SBOX-2365U3	3	65	30-34	307x244		Trunking - In screed U3 (boot with spigot entry)	
SBOX-2365FF	3	65	30-34	No base box		Trunking - Flush screed FF13 / integrated. No base box and supplied with length of flush floor lid and channel	
SBOX-2385C	3	85	35-41	307x227		Conduit	
SBOX-2385U3	3	85	35-41	307x244		Trunking - In screed U3 (boot with spigot entry)	
SBOX-2320C	3	120	63-69	307x227		Conduit	
SBOX-2455C	4	55	28-31	307x244		Conduit boot	
SBOX-2455U3	4	55	28-31	307x244		Trunking - In screed U3 (boot with spigot entry)	
SBOX-2465C	4	65	30-34	307x227		Conduit	
SBOX-2465U3	4	65	30-34	307x244		Trunking - In screed U3 (boot with spigot entry)	
SBOX-2485C	4	85	35-41	307x227		Conduit	
SBOX-2485U3	4	85	35-41	307x244		Trunking - In screed U3 (boot with spigot entry)	
SBOX-2420C	4	120	63-69	307x227		Conduit	

2000 SERIES (cont.)

DRAWINGS

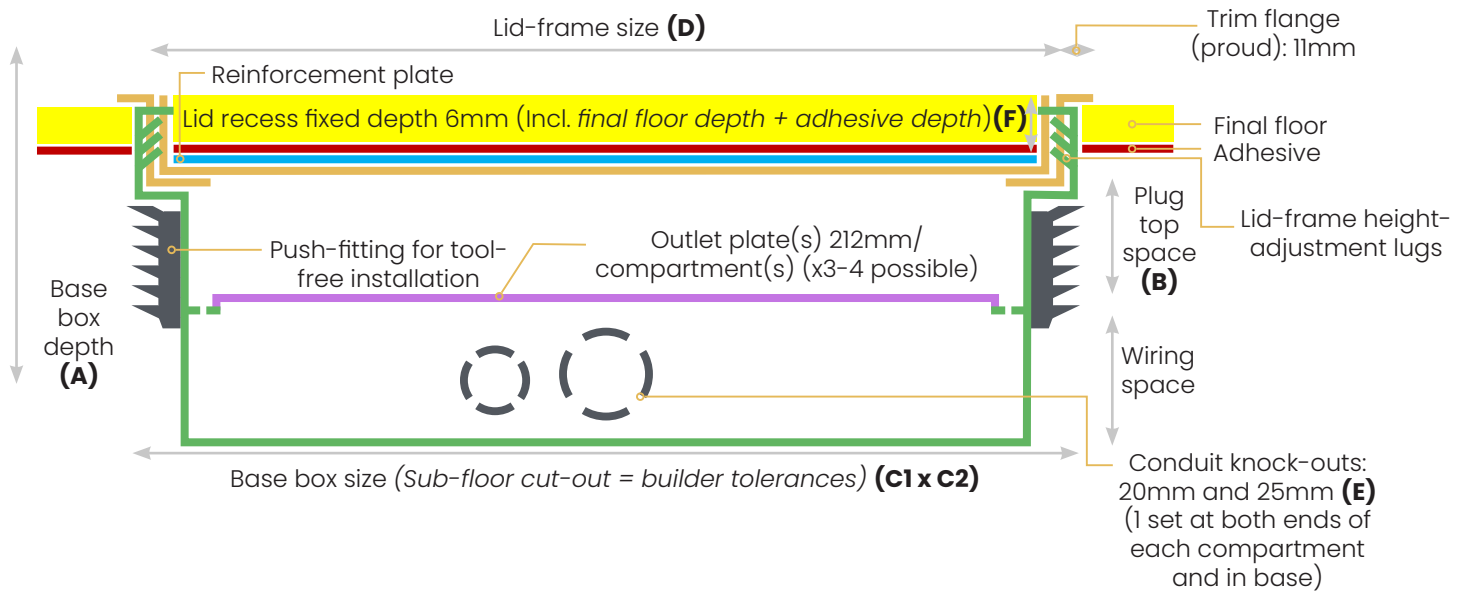
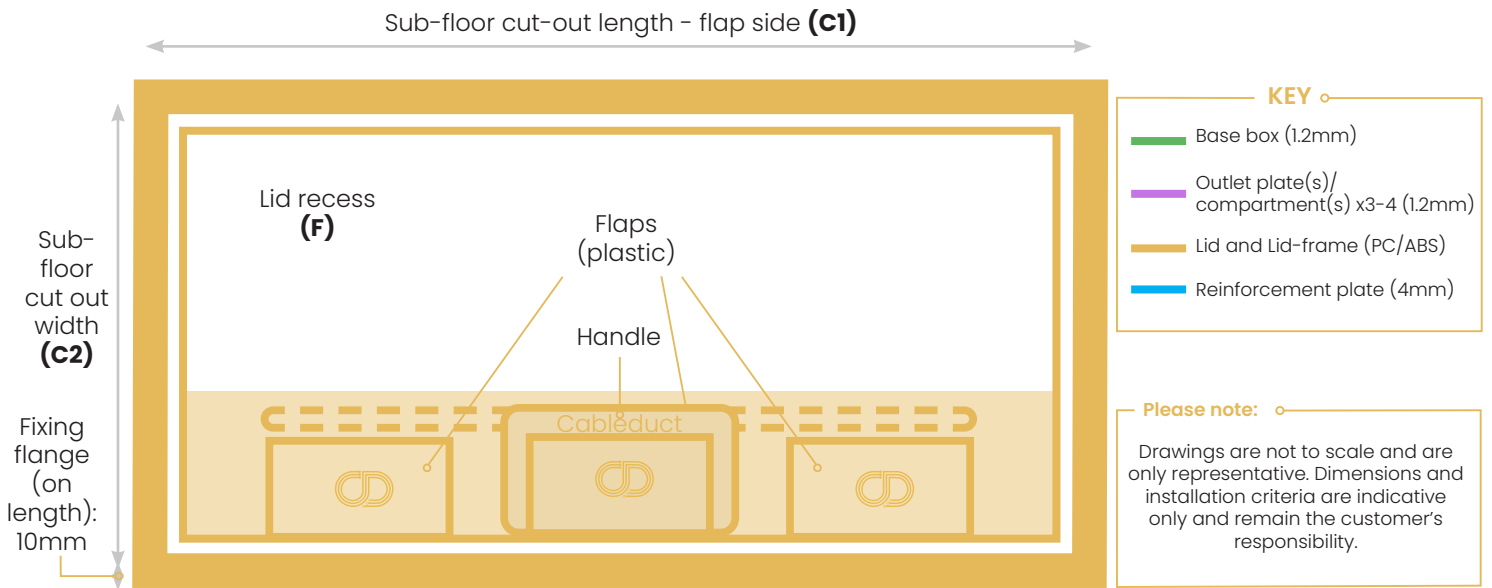

OPTIONS



Lock

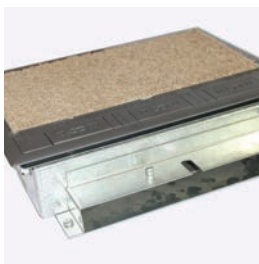

Spigot for in screed trunking (U3 range)

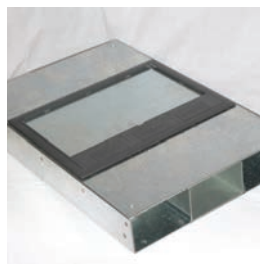

Special trunking lid and channel for flush floor trunking (FF12 & 13 ranges)

TAILORED SOLUTIONS

Cableduct floor boxes and containment solutions can be bespoke designed to meet your exact project specifications.

Whatever size and shape of floor box you need, we can design, manufacture, and supply the perfect solution for you.

Many of our bespoke floor boxes and containment units use the features of our standard products tailored to meet your requirements. This enables us to offer a myriad of solutions to meet almost any of your cable management needs.

YOU DESIGN

What you need your floor box to do and what you want it to look like are paramount for us.

Cableduct take into consideration project details, site conditions and your design intent for the project.

Developing a tailored solution for the interior and exterior of your desired floor box/trunking solution is a consultative process; we're with you every step of the way.

WE BRING TO LIFE

We create bespoke floor box/trunking solutions tailored to suit your specific project requirements.

Our skilled team transform the most intricate floor box design ideas into a high-functioning and aesthetically-attractive reality (i.e. ideas to reality).

We work with each individual client to help realise their vision. We can create any-sized floor box and many bespoke shapes, including parallelograms, triangles and hexagons.

We can also often match your floor box's design with your floor covering and the finish with other accessories in the room for a seamless design.

OUTLET PLATES

CHOOSING YOUR OUTLET PLATES

Please follow these steps to decide which outlet plates and floor box shape work best for your project:

- **First**, decide how many power plug sockets and data/AV points are required.
 - We mount these in metal 'outlet plates' as per "Outlet plate example".
- **Then**, select which outlet plates work best for your combination of power plug sockets and data/AV points using the tables of possible configurations in the following pages:
 - Most popular shown first, then *Options*, for:
 - Double outlet plates.
 - Single outlet plates.
 - Bespoke plates are also possible, on request.

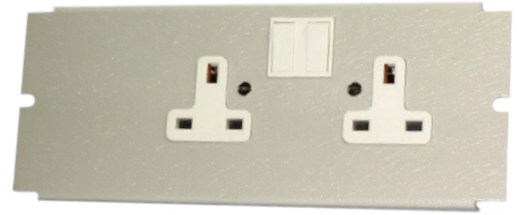

Outlet plate example











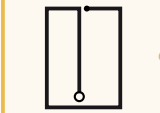
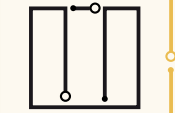
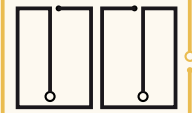

- **Finally**, decide how many outlet plates/compartments you need and which shape of floor box is possible, using the layouts below:

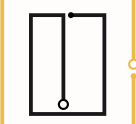
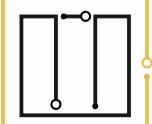
'Outlet plates' are fitted in floor boxes as per *Floor box example*.

Floor box example: 3 x outlet plates/compartments

Floor box size and shape: # outlet plates/compartments

	1 x Single Socket	1 x Twin Socket	2 x	3 x	4 x
 Rectangular Most flexible	N/A				
 Square		N/A			N/A
 Round					N/A

DOUBLE OUTLET PLATES

Options

KEY

55+ for shallower 55mm and 65mm base boxes (side-wired)

85+ for deeper 85mm and 120mm base boxes

85+(65) Ideal for deeper 85mm and 120mm base boxes but can work with 65mm base boxes depending on module

RELEVANT PRODUCT	2000	2000	500 (Rect); 700/ Minima (Rect & Sq)	700/ MINIMA	700/MINIMA	700/ MINIMA	700/ MINIMA	IP65 box: (Base box: 700 = 85mm & 120mm; Minima = 120mm)	700/ MINIMA 169mm Round	700/ MINIMA 169mm Round	
#COMPARTMENTS (c) / OUTLET PLATES	3	4	1-4	1	2 and 3	1	2	1-4	1	1	
SHAPE (Rectangular=Rect; Square=Sq; Round=Rd)	Rect	Rect	Rect/Sq	Sq/Rd	Sq/Rd	Rd	Rd	Rect/Sq	Rd	Rd	
RELEVANT MODEL	3c	4c	ALL Rect; Sq: 300x 300mm	Sq: 150x 150mm, Rd: 127mm	Sq: 200x 200mm; Rd: 193mm & 289mm; RdRet: 289mm	RdRet: 127mm	RdRet: 193mm	ALL Rect, Sq: 300x 300mm	RdStd: 169mm	RdRet: 169mm	
	Blank Plate double	2301	2401	501		7R001		7RO-R01	7R001	7RM01	7RM-R01
	2x 13A unswitched			573				7RO- R13A		7RM73	7RM- R73
	2x standard 1 gang apertures	2358		558							
	2x standard 1 gang apertures - dished 85+			558D							
	3x Euromod 50x50 module 85+(65)			559-S							
	1x Single 13A switched & 1x 1 gang aperture			575							
	1x 13A switched & 1x euromod 50x50 module 85+ (65)			578		7R078				7RM78	
	1x 13A switched & 1x euromod 50x50 module - side-wired 55+			578-S						7RM78-S	
	1x standard 2 gang aperture			586							
	1x dished 2 gang aperture			586D							
	3x 13A switched 85+			588							
	3x 13A switched - side wired 55+			588S							
	3x 13A unswitched 85+	2390	2490	590							
	3x 13A unswitched - side wired 55+			590-S							

DOUBLE OUTLET PLATES











Options

KEY

55+ for shallower 55mm and 65mm base boxes (side-wired)

85+ for deeper 85mm and 120mm base boxes

85+(65) Ideal for deeper 85mm and 120mm base boxes but can work with 65mm base boxes depending on module

RELEVANT PRODUCT	2000	2000	500 (Rect); 700/ Minima (Rect & Sq)	700/ MINIMA	700/MINIMA	700/ MINIMA	700/ MINIMA	IP65 box. (Base box. 700 = 85mm & 120mm; Minima = 120mm)	700/ MINIMA 169mm Round	700/MINIMA 169mm Round
#COMPARTMENTS (c) / OUTLET PLATES	3	4	1-4	1	2 and 3	1	2	1-4	1	1
SHAPE (Rectangular=Rect; Square=Sq; Round=Rd)	Rect	Rect	Rect/Sq	Sq/Rd	Sq/Rd	Rd	Rd	Rect/Sq	Rd	Rd
RELEVANT MODEL	3c	4c	ALL Rect; Sq: 300x 300mm	Sq: 150x 150mm, Rd: 127mm	Sq: 200x 200mm; Rd: 193mm & 289mm; RdRet: 289mm	RdRet: 127mm	RdRet: 193mm	ALL Rect, Sq: 300x 300mm	RdStd: 169mm	RdRet: 169mm
 6x LJ6C cut outs (22.4x36.4mm) 85+(65)	2391S	2491S	591-S					7R091S		
 4x LJ6C cut outs angled plates 85+(65)	2393	2493	593							
 Plate to accept 1x US Decora duplex panel mount 120+ 85+			571		7R071				7RM71	7RM-R71
 1x 13A Unswitched & 1x euromod 50x50 module 85+ (65)										7RM-R78- UNSWITCH
 1x 13A Unswitched & 1x euromod 50x50 module - side wired 85+ (65)										7RM-R78- UNSWITCH-S
 1x 13A switched + 1x 5A 85+(65)									7RM77	
 1x 13A switched + 2x LJ6C 85+									7RM- 13RJ	
 1x 5A + 1x euro 85+(65)									7RM- 5EURO	7RM-R5EURO
 1x 13A Unswitched + 1x 5A										7RM-R77- UNSWITCH
 1x 13A Unswitched + 2x LJ6C 85+										7RM-R13RJ- UNSWITCH

SINGLE OUTLET PLATES







Most popular

KEY

55+ for shallower 55mm and 65mm base boxes (side-wired)

85+ for deeper 85mm and 120mm base boxes

85+(65) Ideal for deeper 85mm and 120mm base boxes but can work with 65mm base boxes depending on module

RELEVANT PRODUCT	2000	2000	500 (Rect); 700/ Minima (Rect & Sq)	700/ MINIMA	700/MINIMA	700/ MINIMA	700/ MINIMA	IP65 box: (Base box 700 = 85mm & 120mm; Minima = 120mm)	700/ MINIMA 169mm Round	700/ MINIMA 169mm Round
#COMPARTMENTS (c) / OUTLET PLATES	3	4	1-4	1	2 and 3	1	2	1-4	1	1
SHAPE (Rectangular=Rect; Square=Sq; Round=Rd)	Rect	Rect	Rect/Sq	Sq/Rd	Sq/Rd	Rd	Rd	Rect/Sq	Rd	Rd
RELEVANT MODEL	3c	4c	ALL Rect; Sq: 300x 300mm	Sq: 150x 150mm, Rd: 127mm	Sq: 200x 200mm; Rd: 193mm & 289mm; RdRet: 289mm	RdRet: 127mm	RdRet: 193mm	ALL Rect, Sq: 300x 300mm	RdStd: 169mm	RdRet: 169mm
 1x 13A switched 85+				7RS- 75W					7RM- 75W	7RM- R75W
 1x 13A switched - side wired 65+				7RS-75S					7RM-75S	7RM- R75S
 1x 13A switched with USB-A 85+				7RS-75- USB					7RM-75- USB	7RM- R75- USB
 1x Euromod 50x50 module 85+(65)				7RS-59		7RS- R59	7RO- R59		7RM-59- SINGLE	7RM- R59- SINGLE
 1x 5A unswitched				7RS- 5AMP		7RS- R-76			7RM57	7RM- R57
 2x LJ6C cut outs (22.4x36.4mm) 85+(65)				7RS-91		7RS- R91			7RM-91- SINGLE	7RM- R91- SINGLE

SINGLE OUTLET PLATES





Options

KEY

55+ for shallower 55mm and 65mm base boxes (side-wired)

85+ for deeper 85mm and 120mm base boxes

85+(65) Ideal for deeper 85mm and 120mm base boxes but can work with 65mm base boxes depending on module

RELEVANT PRODUCT	2000	2000	500 (Rect); 700/ Minima (Rect & Sq)	700/ MINIMA	700/MINIMA	700/ MINIMA	700/ MINIMA	IP65 box: (Base box: 700 = 85mm & 120mm; Minima = 120mm)	700/ MINIMA 169mm Round	700/ MINIMA 169mm Round
#COMPARTMENTS (c) / OUTLET PLATES	3	4	1-4	1	2 and 3	1	2	1-4	1	1
SHAPE (Rectangular=Rect; Square=Sq; Round=Rd)	Rect	Rect	Rect/Sq	Sq/Rd	Sq/Rd	Rd	Rd	Rect/Sq	Rd	Rd
RELEVANT MODEL	3c	4c	ALL Rect; Sq: 300x 300mm	Sq: 150x 150mm, Rd: 127mm	Sq: 200x 200mm; Rd: 193mm & 289mm; RdRet: 289mm	RdRet: 127mm	RdRet: 193mm	ALL Rect, Sq: 300x 300mm	RdStd: 169mm	RdRet: 169mm
 Blank Plate single				7RS01			7RS- R01			
 1x 13A unswitched 85+(65)				7RS-13A			7RS- R13A		7RM-13A	7RM- R13A
 1x standard 1 gang aperture				7RS- 581GAN						
 1x 13A unswitched & 1x LJ6C cut out				7RS- 13RJ						

TRUNKING

UNDERFLOOR IN SCREED

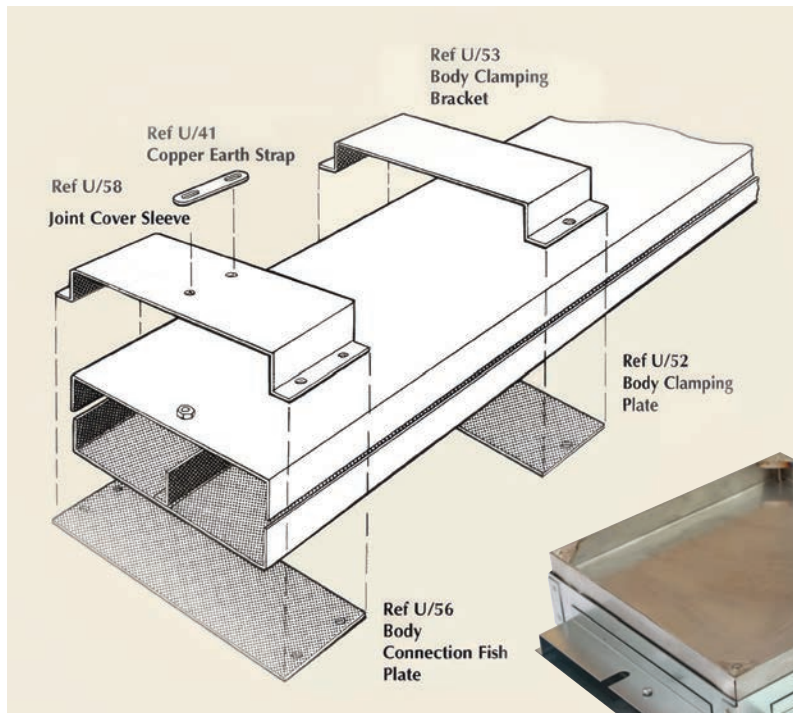

- In screed trunking is buried in the screed during installation to provide a secure, concealed and unobtrusive method of routing electrical and data cables throughout a building.
- Our Minima and 700 series floor boxes integrate seamlessly with our in screed trunking using spigots.
- Additionally, our junction boxes provide access to services and wiring for post-installation maintenance and enable changes in direction of trunking and wiring.



See trunking overview brochure for more product details

OTHER TRUNKING

FLUSH FLOOR

Designed for use in screed floors and to sit flush with the surrounding screed. This provides the best flexibility for moving floor boxes up and down the trunking run, as required.

SURFACE (P.O.A. only)

Surface trunking is installed directly onto a wall, floor, or ceiling to contain unsightly wires and to prevent trip hazards. It is fully customisable and available in any size.

PERIMETER & BENCH

Robust, durable and stylish skirting and dado perimeter trunking for low or mid-level above the floor. Available in a wide variety of sizes, profiles and finishes. Bench trunking is a low-profile solution for worktops.

PEDESTAL BOXES

Pedestal boxes are a neat and unobtrusive choice for desk and worktops in office environments, education establishments and healthcare buildings. Available in a wide variety of sizes, profiles and finishes.



ELEGANT Finishes



CABLEDUCT

— L I M I T E D —

020 8683 1126 | sales@cableductuk.com | www.cableductuk.com

Cableduct Limited, 30 Selhurst Road, London SE25 5QF. Registered Company Number 00364046